



INNOMOUNT – Montagesystem INNOMOUNT – Mounting Solution

GESAMTKATALOG / MAIN CATALOGUE 06/2023



4 **Waffenkennzahlen** / ID Number

6 **Artikelnummer** / Item Number

7 **ZF-Aufnahmen** / Scope supports

8 **Übersicht Optoelektronik**
Overview Optoelektronik

12 **Weaver/Picatinny**
Klassische Zieloptik / Classic optics
Reflexvisiere / Red Dot Sight
Optoelektronik / Optoelektronik
Optoelektronik Multifunktionsmontage /
Optoelektronik multi function mounts

26 **Blaser**
Klassische Zieloptik / Classic optics
Reflexvisiere / Red Dot Sight
Optoelektronik / Optoelektronik
Optoelektronik Multifunktionsmontage /
Optoelektronik multi function mounts

34 **Sauer 404**
Klassische Zieloptik / Classic optics
Reflexvisiere / Red Dot Sight
Optoelektronik / Optoelektronik
Optoelektronik Multifunktionsmontage /
Optoelektronik multi function mounts

42 **Sauer 303**
Klassische Zieloptik / Classic optics
Reflexvisiere / Red Dot Sight
Optoelektronik / Optoelektronik

48 **Tikka T3/T3X**
Klassische Zieloptik / Classic optics
Reflexvisiere / Red Dot Sight
Optoelektronik / Optoelektronik

54 **CZ 550/557**
Klassische Zieloptik / Classic optics
Optoelektronik / Optoelektronik

60 **Merkel**
Klassische Zieloptik / Classic optics
Reflexvisiere / Red Dot Sight
Optoelektronik / Optoelektronik

66 **12mm Prisma**
Klassische Zieloptik / Classic optics

68 **Multirail/Picatinnyrail**
Multirail/Picatinnyrail

69 **Basen - Weaver - Zweiteilig**
Bases - Weaver - two piece

70 **Double Sight**
Double Sight

73 **Brückenschwenkmontagen**
Swing mounts

75 **Bestellbeispiel**
Order example

76 **Taktische Montagen**
Tactical mount

78 **Taktische Montagen - Flex**
Tactical mount - flex



WAFFENKENNZAHLEN

ID NUMBER

Bestellbeispiel:
70-SR-11-002-010-150-086

Weitere Bauhöhen:
70-SR-11-004-030-150-086
70-SR-11-006-050-150-086

Fabrikat	Modell	WKZ	Weaverbasen		Schwenkmontage - Oberteile			
			2tlg.	15mm Prisma - (-150)		EAW (-160)		
				Bauhöhe Vorderfuss* XXX	Bauhöhe Distanzrolle* YYY	Bauhöhe Vorderfuss* XXX	Bauhöhe Distanzrolle* YYY	
Anschütz	1574	154	x	002	025	004	010	
Anschütz	1780	151	x	002	010	006	015	
Anschütz	1770 / Match 54	001		002	010	006	015	
Anschütz	Match 64	028		002	010	006	015	
Antonio Zoli	1900 Reptierer	305	x	002	035	004	020	
Benelli	Argo	273	x	002	010	006	015	
BRNO	CZ531	965		002	040	004	025	
BRNO	Scandinavian	048		002	040	004	025	
BSA	Repetierer	927		002	040	004	025	
Carl Gustav	1900	005	x	002	035	004	020	
Carl Gustav	2000	194	x	002	010	206	015	
Carl Gustav	3000	215	x	002	010	006	015	
Carl Gustav	4000	259	x	002	010	006	015	
Fabarm	liris	403	x	002	010	006	015	
FN Browning	A-Bolt, Eurobolt	002		002	010	006	015	
FN Browning	BAR / MARAL	003	x	002	010	006	015	
FN Browning	BLR	103	x	002	010	006	015	
FN Browning	Brow Mauser	004	x	002	050	002	015	
FN Browning	European	143	x	002	010	006	015	
Haenel	Jäger 10, ab Nr. 921	226	x	206	080	206	045	
Heckler & Koch	SLB 2000-Light	187	x	002	010	006	015	
Heym	SR 20	060	x	002	050	002	015	
Heym	SR 21	306	x	206	065	206	030	
Heym	SR 30	206	x	206	065	206	030	
Howa	1500	218	x	206	080	206	045	
Kepplinger	Repetierer	955		002	040	004	025	
Krico	600,700,900,902	006	x	002	025	004	010	
Marlin	1895/444/338/336/308	036		002	010	006	015	
Mauser	97	029		002	030	004	015	
Mauser	225 Titan	145	x	002	035	004	020	
Mauser	94-96<	156		002	040	004	025	
Mauser	94-96>	256		002	030	004	015	
Mauser	K98 / M12	010	x	002	050	002	015	
Mauser	M18	007	x	206	080	206	045	
Merkel	SR 1	186	x	002	015	006	020	
Merkel	SR 1 Basic	286	x	002	010	006	015	
Parker Hale	Safari 1200	011		002	050	002	015	
Pfeifer	SR2	030		002	010	006	015	
Remington	700 short / long action	012	x	206	080	206	045	
Remington	7400-7600-750	013	x	002	010	006	015	
Remington	750/740/742/760	074	x	002	010	006	015	
Remington	Seven / 600/ 673	078		002	040	004	025	

Fabrikat	Modell	WKZ	Weaverbasen		Schwenkmontage - Oberteile			
			2tlg.	15mm Prisma - (-150)		EAW (-160)		
				Bauhöhe Vorderfuss* XXX	Bauhöhe Distanzrolle* YYY	Bauhöhe Vorderfuss* XXX	Bauhöhe Distanzrolle* YYY	
Rössler	Titan 16	031		206	070	206	035	
Rössler	Titan 6 / Titan 3	459	x	206	050	206	015	
Sabatti	Rover	155		002	040	004	025	
Santa Barbara	Mauser	044	x	002	050	002	015	
Sauer	200	059	x	002	010	006	015	
Sauer	100/101	014	x	206	080	206	045	
Sauer	202 Standard / Magnum	406	x	002	025	004	010	
Sauer	80,90,92	015	x	002	010	006	015	
Savage	110,116	016		206	050	206	015	
Schultz & Larsen	M 97 DL	199		002	030	004	015	
Steyr	Mod L	093	x	002	010	006	015	
Steyr	Mod M Luxus L M S	086	x	002	010	006	015	
Steyr	Mod M72	019		002	010	006	015	
Steyr	Mod SL	017	x	002	010	006	015	
Steyr	SBS96/SM12/Classic	027	x	002	010	006	015	
Tikka	T3(x)	400		002	010	006	015	
Swiss Arms	SHR 970	175	x	002	010	006	015	
Verney Carron	Auto Impact	405		002	025	004	010	
Verney Carron	L.A.	032		002	010	006	015	
Verney Carron	Repetierer	919		002	025	004	010	
Voere	Kuffstein 2165	021	x	002	050	002	015	
Voere Neu!Alu	Automat 2185	141	x	002	010	006	015	
Voere Neu!Alu	Titan II	045	x	002	035	004	020	
Weatherby	.240 Weath	058		002	025	004	010	
Weatherby	Mark V,Vanguard	023		206	080	206	045	
Winchester	M70 .223WQD	117		002	045	002	010	
Winchester	Mod 70	024		002	045	002	010	
Zastava	Mini Mauser	107		002	040	004	025	
Zastava	Mod 70	049	x	002	050	002	015	

* kleinstmögliche Bauhöhen
* minimum construction heights



ARTIKELNUMMER

ITEM NUMBER

Montagetyp / Mounting type

Oberteil / Upper part

Bauhöhe / Construction height

Angaben in mm / dimensions in mm

Kröpfung / Offset

Angaben in mm / dimensions in mm

Waffenkennzahl / Weapon code

Vorneigung / Pre-tilt

Angaben in MOA / data in MOA

50-SR-07-00-200-20MOA

- 40 - ZERO einteilig
- 41 - ZERO zweiteilig
- 44 - ZERO zweiteilig variabel
- 45 - ZERO multifunktional
- 50 - QD einteilig
- 51 - QD zweiteilig
- 52 - QD Reflexvisiere
- 53 - FM einteilig
- 54 - QD zweiteilig variabel
- 55 - QD multifunktional
- 56 - FM zweiteilig variabel
- 57 - FM zweiteilig

- | | |
|---|--------------------------------------|
| 26 - Ringe 25,4/26 mm | 100 - INNOGUN |
| 30 - Ringe 30 mm | 200 - Weaver / Picatinny |
| 34 - Ringe 34 mm | 400 - Tikka T3/T3x |
| 35 - Ringe 35 mm | 520 - CZ 550 / CZ 557 |
| 36 - Ringe 36 mm | 600 - Sauer 303 |
| 40 - Ringe 40 mm | 650 - Sauer 404 |
| SR - Swarovskischiene | 800 - Blaser |
| VM - Zeisschiene | 900 - Merkel B3 / B4 / KR1 / K3 / K5 |
| SB - S&B Convexchiene | 950 - 12 mm Prisma |
| LM - 70° Prismenschiene | |
| PT - Picatinny | |
| DS - Docter sight Kahles Helia RD | |
| AM - Aimpoint Micro Holosun | |
| PA - Pulsar APEX Digisight Trail - Yukon Sightline N455S Sightline N475S | |
| PA2 - Pulsar Trail2 / LRF Digisight Ultra N355 Digisight Ultra N450 / LRF | |
| TH - Pulsar Thermion I+II/Pro/LRF Thermion Duo DXP50 Duo DXP55 | |
| DE - Pulsar Digex - InfiRay Tube TD 50L - Hikmicro Alpex A50T A50TN | |
| TN - Pulsar Talion XQ38 XG35 | |
| ATN - ATN Thor Mars X-Sight I + II | |
| ATN4/5 - ATN4 Thor 4 Thor LT X-Sight 4K Pro X-Sight LTV X-Sight 4K INT | |
| IRX - InfiRay Xsight SH 50 SL 50 - Liemke Sperber 50 / 64 - Lahoux Scope Elite 50 | |
| IRR - InfiRay Rico RH 35 RH 50 RL 42 | |
| IRS - InfiRay Saim SCP 19 SCL 35 SCT 35 SCH 50 SCT 35 V2 | |
| IRM - Liemke Sperber 19 25 35 - Night Pearl Fox 19 Hunt Fox 35 Elite II Fox 35 Hunt | |
| SE - InfiRay CML 25 | |
| HMT - InfiRay Tube TL25 SE TL35 SE | |
| DH - Hikmicro Thunder TH 25 TH 35 TE 19 PRO TE 25 PRO TQ 35 PRO TQ 50 PRO | |
| FG - Panther PH 35L PH 50L PQ 35L PQ 50L Cheetah C32F-S SL SN SNL | |
| FG1 - Dedal Hunter | |
| GT - Fortuna General | |
| AR - Fortuna General One | |
| PD - Guide TS450 | |
| PD2 - TVT Archer TSA | |
| YP - Pard NV008P NV008P LRF SA 19 25 35 45 LRF - Sytong HT 60 | |
| | Pard NV008S NV008S LRF |
| | Yukon Photon |

ZF-AUFNAHMEN

SCOPE SUPPORTS

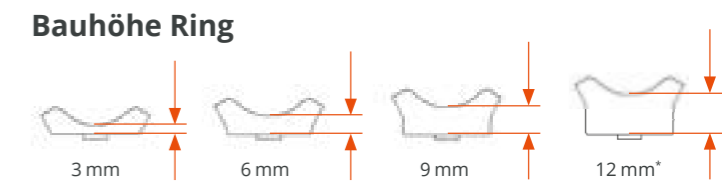
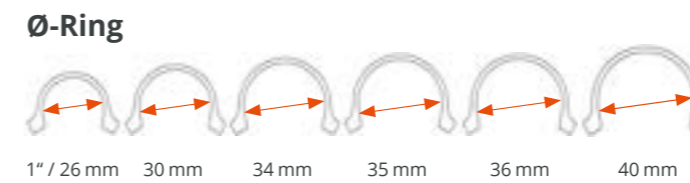
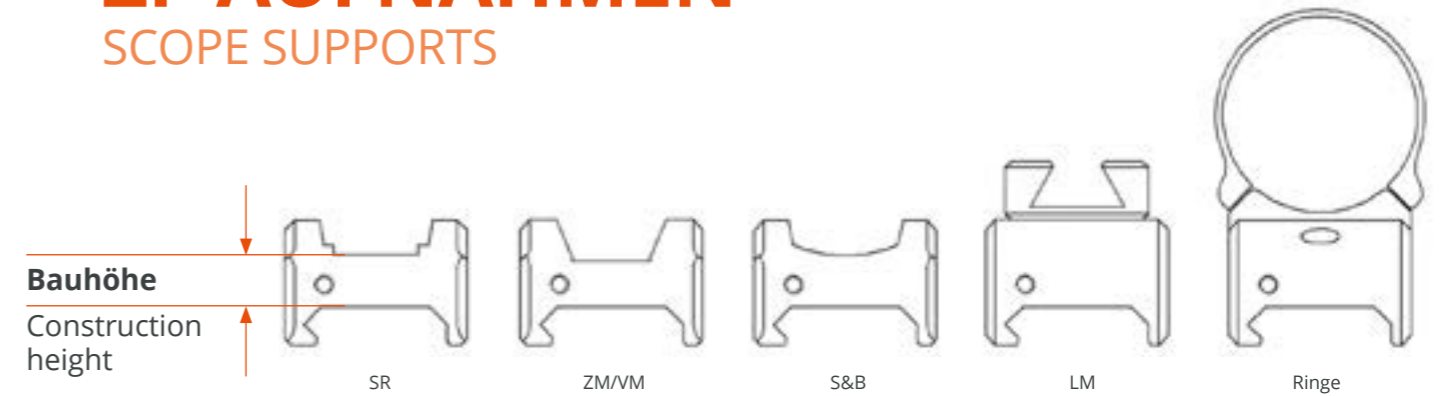

*nur bei Ø 30 mm

Richtige Bauhöhe

Correct construction height

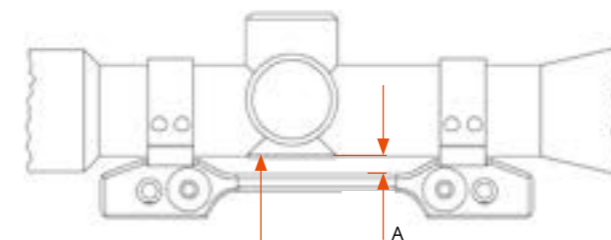

Richtige Bauhöhe? Verstellurmunterseite beachten!
Correct construction height? Turret bottom!

Modell / model	A (mm) Ring standard
Innogun (100)	1,5
Blaser (800)	1,5
Merkel (900)	1,5
12 mm - Prisma (950)	1,5
Weaver/Picatinny (200)	6
Tikka T3/T3x (400)	6
CZ 550 (520)	4
Sauer 303 (600)	4
Sauer 404 (650)	1,5

Verschlussarten



QD - Schnellspanverschluss
QD - Quick Detach



ZERO - Schnellspanverschluss
ZERO - Quick Detach



FM - Festverschluss
FM - Fix Detach

ÜBERSICHT OPTOELEKTRONIK

OVERVIEW OPTOELEKTRONIC

	Abkürzung Abbreviation	Modell Model	Abbildung Illustration
PULSAR	PA	APEX	
	PA	Digisight	
	PA	Trail	
	PA2	Trail2 LRF	
	PA2	Digisight Ultra N355 Digisight Ultra N450 / LRF Digisight Ultra N455 / LRF	
	TH	Pulsar Thermion I+II/Pro/LRF Thermion Duo DXP50 DXP55	
	DE	Digex N450 N455 C50	
	TN	Pulsar Talion XQ38 XG35	
ATN	ATN	Thor Mars X-Sight I + II	
	ATN4 ATN5	Thor 4 Thor LT X-Sight 4K Pro X-Sight LTV X-Sight 4K INT	
PARD	PD	NV008P NV008P LRF SA 19 25 35 45 LRF	
	PD2	NV008S NV008S LRF	
SYTONG	PD	HT 60	

	Abkürzung Abbreviation	Modell Model	Abbildung Illustration
INFIRAY	IRR	Rico RH 35 RH 50 RL 42	
	IRS	Saim SCP 19 SCL 35 SCT 35 SCH 50 SCT 35 V2	
	TH	Tube TL 35 Tube TH 35 Tube TH 50	
	IRX	Xsight SH 50 SL 50	
	DE	Tube TD 50L Tube TH 50 V2	
	SE	Tube TL25 SE TL35 SE	
HIKIMICRO	HMT	Thunder TH 25 TH 35 TE 19 PRO TE 25 PRO TQ 35 PRO TQ 50 PRO Panther PH 35L PH 50L PQ 35L PQ 50L Cheetah C32F-S SL SN SNL	
	TH	Stellar SH 35 SQ 35 Stellar SH 50 SQ 50	
	DE	Alpex A50T A50TN	
GUIDE	GT	TS 450	
	TH	TU 420 TU 430 TU 450 TU 620 TU 630 TU 650	
FORTUNA	FG	Fortuna General	
	FG1	Fortuna General One	
THERMTEC	TH	Ares 335 360 635 660	

ÜBERSICHT OPTOELEKTRONIK

OVERVIEW OPTOELEKTRONIC

	Abkürzung Abbreviation	Modell Model	Abbildung Illustration
DEDAL	DH	Hunter	
LIEMKE	IRS	Sperber 19 25 35	
	IRX	Sperber 50 64	
LAHOUX	TH	Sight 35	
	IRX	Scope Elite 50	
YUKON	YP	Photon	
	PA	Sightline N455S Sightline N475S	
GSCI	GSWH	Wolfhound	
TVT	AR	Archer TSA	
NIGHT PEARL	IRS	Fox 19 Hunt Fox 35 Elite II Fox 35 Hunt	
	TH	Marten TU 420 Marten TU 430 Marten TU 450 Marten TU 650	



FÜR **WEAVER/PICATINNY**

FÜR WEAVER/PICATINNY (200)

¹ Auch passend für Merkel Helix / Steel Action / Sako S20 / Benelli Lupo etc.; Achsmaß der Klemmelemente 110 mm







¹ Also fits Merkel Helix / Steel Action / Sako S20 / Benelli Lupo etc.; Axis dimension of clamp 110 mm

² Auch passend für Strasser / Benelli Argo etc.; Achsmaß der Klemmelemente 85 mm







² Also fits Strasser / Benelli Argo etc.; Axis dimension of clamp 85 mm

	Bauhöhe	Zero	QD	FM	Ansicht QD
--	---------	------	----	----	------------

RINGMONTAGE 1"/26 MM







Ø 1"/26	einteilig	BH 14 BH 17 BH 20	40-26-14-00-200 40-26-17-00-200 40-26-20-00-200	50-26-14-00-200 50-26-17-00-200 50-26-20-00-200	53-26-14-00-200 53-26-17-00-200 53-26-20-00-200		^{1*}
	einteilig 20 MOA	BH 14 BH 17 BH 20	40-26-14-00-200-20MOA 40-26-17-00-200-20MOA 40-26-20-00-200-20MOA	50-26-14-00-200-20MOA 50-26-17-00-200-20MOA 50-26-20-00-200-20MOA	53-26-14-00-200-20MOA 53-26-17-00-200-20MOA 53-26-20-00-200-20MOA		^{1*}
	einteilig gekröpft	BH 14 BH 17 BH 20	40-26-14-25-200 40-26-17-25-200 40-26-20-25-200	50-26-14-25-200 50-26-17-25-200 50-26-20-25-200	53-26-14-25-200 53-26-17-25-200 53-26-20-25-200		^{2*}
	einteilig gekröpft 20 MOA	BH 14 BH 17 BH 20	40-26-14-25-200-20MOA 40-26-17-25-200-20MOA 40-26-20-25-200-20MOA	50-26-14-25-200-20MOA 50-26-17-25-200-20MOA 50-26-20-25-200-20MOA	53-26-14-25-200-20MOA 53-26-17-25-200-20MOA 53-26-20-25-200-20MOA		^{2*}
	zweiteilig	BH 14 BH 17 BH 20	41-26-14-00-200 41-26-17-00-200 41-26-20-00-200	51-26-14-00-200 51-26-17-00-200 51-26-20-00-200	57-26-14-00-200 57-26-17-00-200 57-26-20-00-200		^{**}
	zweiteilig gekröpft	BH 14 BH 17 BH 20	41-26-14-25-200 41-26-17-25-200 41-26-20-25-200	51-26-14-25-200 51-26-17-25-200 51-26-20-25-200	57-26-14-25-200 57-26-17-25-200 57-26-20-25-200		^{**}
	zweiteilig variabel	BH 20 BH 23 BH 26	44-26-20-00-200 44-26-23-00-200 44-26-26-00-200	54-26-20-00-200 54-26-23-00-200 54-26-26-00-200	56-26-20-00-200 56-26-23-00-200 56-26-26-00-200		^{**}

RINGMONTAGE 30 MM







Ø 30	einteilig	BH 14 BH 17 BH 20 BH 23	40-30-14-00-200 40-30-17-00-200 40-30-20-00-200 40-30-23-00-200	50-30-14-00-200 50-30-17-00-200 50-30-20-00-200 50-30-23-00-200	53-30-14-00-200 53-30-17-00-200 53-30-20-00-200 53-30-23-00-200		^{1*}
	einteilig 20 MOA	BH 14 BH 17 BH 20 BH 23	40-30-14-00-200-20MOA 40-30-17-00-200-20MOA 40-30-20-00-200-20MOA 40-30-23-00-200-20MOA	50-30-14-00-200-20MOA 50-30-17-00-200-20MOA 50-30-20-00-200-20MOA 50-30-23-00-200-20MOA	53-30-14-00-200-20MOA 53-30-17-00-200-20MOA 53-30-20-00-200-20MOA 53-30-23-00-200-20MOA		^{1*}
	einteilig gekröpft	BH 14 BH 17 BH 20 BH 23	40-30-14-25-200 40-30-17-25-200 40-30-20-25-200 40-30-23-25-200	50-30-14-25-200 50-30-17-25-200 50-30-20-25-200 50-30-23-25-200	53-30-14-25-200 53-30-17-25-200 53-30-20-25-200 53-30-23-25-200		^{2*}
	einteilig gekröpft 20 MOA	BH 14 BH 17 BH 20 BH 23	40-30-14-25-200-20MOA 40-30-17-25-200-20MOA 40-30-20-25-200-20MOA 40-30-23-25-200-20MOA	50-30-14-25-200-20MOA 50-30-17-25-200-20MOA 50-30-20-25-200-20MOA 50-30-23-25-200-20MOA	53-30-14-25-200-20MOA 53-30-17-25-200-20MOA 53-30-20-25-200-20MOA 53-30-23-25-200-20MOA		^{2*}
	zweiteilig	BH 14 BH 17 BH 20 BH 23	41-30-14-00-200 41-30-17-00-200 41-30-20-00-200 41-30-23-00-200	51-30-14-00-200 51-30-17-00-200 51-30-20-00-200 51-30-23-00-200	57-30-14-00-200 57-30-17-00-200 57-30-20-00-200 57-30-23-00-200		^{**}
	zweiteilig gekröpft	BH 14 BH 17 BH 20 BH 23	41-30-14-25-200 41-30-17-25-200 41-30-20-25-200 41-30-23-25-200	51-30-14-25-200 51-30-17-25-200 51-30-20-25-200 51-30-23-25-200	57-30-14-25-200 57-30-17-25-200 57-30-20-25-200 57-30-23-25-200		^{**}
	zweiteilig variabel	BH 20 BH 23 BH 26 BH 29	44-30-20-00-200 44-30-23-00-200 44-30-26-00-200 44-30-29-00-200	54-30-20-00-200 54-30-23-00-200 54-30-26-00-200 54-30-29-00-200	56-30-20-00-200 56-30-23-00-200 56-30-26-00-200 56-30-29-00-200		^{**}

	Bauhöhe	Zero	QD	FM	Ansicht QD
--	---------	------	----	----	------------

RINGMONTAGE 34 MM

Ø 34	einteilig	BH 14 BH 17 BH 20	40-34-14-00-200 40-34-17-00-200 40-34-20-00-200	50-34-14-00-200 50-34-17-00-200 50-34-20-00-200	53-34-14-00-200 53-34-17-00-200 53-34-20-00-200		^{1*}
	einteilig 20 MOA	BH 14 BH 17 BH 20	40-34-14-00-200-20MOA 40-34-17-00-200-20MOA 40-34-20-00-200-20MOA	50-34-14-00-200-20MOA 50-34-17-00-200-20MOA 50-34-20-00-200-20MOA	53-34-14-00-200-20MOA 53-34-17-00-200-20MOA 53-34-20-00-200-20MOA		^{1*}
	einteilig gekröpft	BH 14 BH 17 BH 20	40-34-14-25-200 40-34-17-25-200 40-34-20-25-200	50-34-14-25-200 50-34-17-25-200 50-34-20-25-200	53-34-14-25-200 53-34-17-25-200 53-34-20-25-200		^{2*}
	einteilig gekröpft 20 MOA	BH 14 BH 17 BH 20	40-34-14-25-200-20MOA 40-34-17-25-200-20MOA 40-34-20-25-200-20MOA	50-34-14-25-200-20MOA 50-34-17-25-200-20MOA 50-34-20-25-200-20MOA	53-34-14-25-200-20MOA 53-34-17-25-200-20MOA 53-34-20-25-200-20MOA		^{2*}
	zweiteilig	BH 14 BH 17 BH 20	41-34-14-00-200 41-34-17-00-200 41-34-20-00-200	51-34-14-00-200 51-34-17-00-200 51-34-20-00-200	57-34-14-00-200 57-34-17-00-200 57-34-20-00-200		^{**}
	zweiteilig gekröpft	BH 14 BH 17 BH 20	41-34-14-25-200 41-34-17-25-200 41-34-20-25-200	51-34-14-25-200 51-34-17-25-200 51-34-20-25-200	57-34-14-25-200 57-34-17-25-200 57-34-20-25-200		^{**}
	zweiteilig variabel	BH 20 BH 23 BH 26	44-34-20-00-200 44-34-23-00-200 44-34-26-00-200	54-34-20-00-200 54-34-23-00-200 54-34-26-00-200	56-34-20-00-200 56-34-23-00-200 56-34-26-00-200		^{**}

RINGMONTAGE 35 MM

Ø 35	einteilig	BH 14 BH 17 BH 20	40-35-14-00-200 40-35-17-00-200 40-35-20-00-200	50-35-14-00-200 50-35-17-00-200 50-35-20-00-200	53-35-14-00-200 53-35-17-00-200 53-35-20-00-200		^{1*}
	einteilig 20 MOA	BH 14 BH 17 BH 20	40-35-14-00-200-20MOA 40-35-17-00-200-20MOA 40-35-20-00-200-20MOA	50-35-14-00-200-20MOA 50-35-17-00-200-20MOA 50-35-20-00-200-20MOA	53-35-14-00-200-20MOA 53-35-17-00-200-20MOA 53-35-20-00-200-20MOA		^{1*}
	einteilig gekröpft	BH 14 BH 17 BH 20	40-35-14-25-200 40-35-17-25-200 40-35-20-25-200	50-35-14-25-200 50-35-17-25-200 50-35-20-25-200	53-35-14-25-200 53-35-17-25-200 53-35-20-25-200		^{2*}
	einteilig gekröpft 20 MOA	BH 14 BH 17 BH 20	40-35-14-25-200-20MOA 40-35-17-25-200-20MOA 40-35-20-25-200-20MOA	50-35-14-25-200-20MOA 50-35-17-25-200-20MOA 50-35-20-25-200-20MOA	53-35-14-25-200-20MOA 53-35-17-25-200-20MOA 53-35-20-25-200-20MOA		^{2*}
	zweiteilig	BH 14 BH 17 BH 20	41-35-14-00-200 41-35-17-00-200 41-35-20-00-200	51-35-14-00-200 51-35-17-00-200 51-35-20-00-200	57-35-14-00-200 57-35-17-00-200 57-35-20-00-200		^{**}
	zweiteilig gekröpft	BH 14 BH 17 BH 20	41-35-14-25-200 41-35-17-25-200 41-35-20-25-200	51-35-14-25-200 51-35-17-25-200 51-35-20-25-200	57-35-14-25-200 57-35-17-25-200 57-35-20-25-200		^{**}
	zweiteilig variabel	BH 20 BH 23 BH 26	44-34-20-00-200 44-34-23-00-200 44-34-26-00-200	54-34-20-00-200 54-34-23-00-200 54-34-26-00-200	56-34-20-00-200 56-34-23-00-200 56-34-26-00-200		^{**}

*Axialanschlag 5 mm (optional 3,8 mm) *Axial stop 5mm (optional 3,8 mm) | **Axialanschlag 3,8 mm **Axial stop 3,8 mm

FÜR **WEAVER/PICATINNY** (200)

¹ Auch passend für Merkel Helix / Steel Action / Sako S20 / Benelli Lupo etc.; Achsmaß der Klemmelemente 110 mm

¹ Also fits Merkel Helix / Steel Action / Sako S20 / Benelli Lupo etc.; Axis dimension of clamp 110 mm







² Auch passend für Strasser / Benelli Argo etc.; Achsmaß der Klemmelemente 85 mm

² Also fits Strasser / Benelli Argo etc.; Axis dimension of clamp 85 mm

	Bauhöhe	Zero	QD	FM	Ansicht QD
--	---------	------	----	----	------------







RINGMONTAGE 36 MM

Ø 36

Ø 36	einteilig	BH 14 BH 17 BH 20	40-36-14-00-200 40-36-17-00-200 40-36-20-00-200	50-36-14-00-200 50-36-17-00-200 50-36-20-00-200	53-36-14-00-200 53-36-17-00-200 53-36-20-00-200	 ^{1*}
	einteilig 20 MOA	BH 14 BH 17 BH 20	40-36-14-00-200-20MOA 40-36-17-00-200-20MOA 40-36-20-00-200-20MOA	50-36-14-00-200-20MOA 50-36-17-00-200-20MOA 50-36-20-00-200-20MOA	53-36-14-00-200-20MOA 53-36-17-00-200-20MOA 53-36-20-00-200-20MOA	 ^{1*}
	einteilig gekröpft	BH 14 BH 17 BH 20	40-36-14-25-200 40-36-17-25-200 40-36-20-25-200	50-36-14-25-200 50-36-17-25-200 50-36-20-25-200	53-36-14-25-200 53-36-17-25-200 53-36-20-25-200	 ^{2*}
	einteilig gekröpft 20 MOA	BH 14 BH 17 BH 20	40-36-14-25-200-20MOA 40-36-17-25-200-20MOA 40-36-20-25-200-20MOA	50-36-14-25-200-20MOA 50-36-17-25-200-20MOA 50-36-20-25-200-20MOA	53-36-14-25-200-20MOA 53-36-17-25-200-20MOA 53-36-20-25-200-20MOA	 ^{2*}
	zweiteilig	BH 14 BH 17 BH 20	41-36-14-00-200 41-36-17-00-200 41-36-20-00-200	51-36-14-00-200 51-36-17-00-200 51-36-20-00-200	57-36-14-00-200 57-36-17-00-200 57-36-20-00-200	 ^{**}
	zweiteilig gekröpft	BH 14 BH 17 BH 20	41-36-14-25-200 41-36-17-25-200 41-36-20-25-200	51-36-14-25-200 51-36-17-25-200 51-36-20-25-200	57-36-14-25-200 57-36-17-25-200 57-36-20-25-200	 ^{**}
	zweiteilig variabel	BH 20 BH 23 BH 26 BH 29	44-30-20-00-200 44-30-23-00-200 44-30-26-00-200 44-30-29-00-200	54-30-20-00-200 54-30-23-00-200 54-30-26-00-200 54-30-29-00-200	56-30-20-00-200 56-30-23-00-200 56-30-26-00-200 56-30-29-00-200	 ^{**}

RINGMONTAGE 40 MM

Ø 40

Ø 40	einteilig	BH 14 BH 17 BH 20	40-40-14-00-200 40-40-17-00-200 40-40-20-00-200	50-40-14-00-200 50-40-17-00-200 50-40-20-00-200	53-40-14-00-200 53-40-17-00-200 53-40-20-00-200	 ^{1*}
	einteilig 20 MOA	BH 14 BH 17 BH 20	40-40-14-00-200-20MOA 40-40-17-00-200-20MOA 40-40-20-00-200-20MOA	50-40-14-00-200-20MOA 50-40-17-00-200-20MOA 50-40-20-00-200-20MOA	53-40-14-00-200-20MOA 53-40-17-00-200-20MOA 53-40-20-00-200-20MOA	 ^{1*}
	einteilig gekröpft	BH 14 BH 17 BH 20	40-40-14-25-200 40-40-17-25-200 40-40-20-25-200	50-40-14-25-200 50-40-17-25-200 50-40-20-25-200	53-40-14-25-200 53-40-17-25-200 53-40-20-25-200	 ^{2*}
	einteilig gekröpft 20 MOA	BH 14 BH 17 BH 20	40-40-14-25-200-20MOA 40-40-17-25-200-20MOA 40-40-20-25-200-20MOA	50-40-14-25-200-20MOA 50-40-17-25-200-20MOA 50-40-20-25-200-20MOA	53-40-14-25-200-20MOA 53-40-17-25-200-20MOA 53-40-20-25-200-20MOA	 ^{2*}
	zweiteilig	BH 14 BH 17 BH 20	41-40-14-00-200 41-40-17-00-200 41-40-20-00-200	51-40-14-00-200 51-40-17-00-200 51-40-20-00-200	57-40-14-00-200 57-40-17-00-200 57-40-20-00-200	 ^{**}
	zweiteilig gekröpft	BH 14 BH 17 BH 20	41-40-14-25-200 41-40-17-25-200 41-40-20-25-200	51-40-14-25-200 51-40-17-25-200 51-40-20-25-200	57-40-14-25-200 57-40-17-25-200 57-40-20-25-200	 ^{**}
	zweiteilig variabel	BH 20 BH 23 BH 26	44-40-20-00-200 44-40-23-00-200 44-40-26-00-200	54-40-20-00-200 54-40-23-00-200 54-40-26-00-200	56-40-20-00-200 56-40-23-00-200 56-40-26-00-200	 ^{**}

*Axialanschlag 5 mm (optional 3,8 mm) *Axial stop 5mm (optional 3,8 mm) | **Axialanschlag 3,8 mm **Axial stop 3,8 mm



FÜR WEAVER/PICATINNY (200)

¹ Auch passend für Merkel Helix / Steel Action / Sako S20 / Benelli Lupo etc.; Achsmaß der Klemmelemente 110 mm





¹ Also fits Merkel Helix / Steel Action / Sako S20 / Benelli Lupo etc.; Axis dimension of clamp 110 mm

² Auch passend für Strasser / Benelli Argo etc.; Achsmaß der Klemmelemente 85 mm

² Also fits Strasser / Benelli Argo etc.; Axis dimension of clamp 85 mm





	Bauhöhe	Zero	QD	FM	Ansicht QD	
SWAROVSKI SR						
SR	einteilig	BH 8 BH 20	40-SR-08-00-200 40-SR-20-00-200	50-SR-08-00-200 50-SR-20-00-200	53-SR-08-00-200 53-SR-20-00-200	 ^{1*}
	einteilig gekröpft	BH 8	40-SR-08-25-200	50-SR-08-25-200	53-SR-08-25-200	 ^{2*}
	zweiteilig	BH 8	41-SR-08-00-200	51-SR-08-00-200	57-SR-08-00-200	 **
	zweiteilig gekröpft	BH 8	41-SR-08-25-200	51-SR-08-25-200	57-SR-08-25-200	 **
	zweiteilig variabel	BH 15	44-SR-15-00-200	54-SR-15-00-200	56-SR-15-00-200	 **

ZEISS ZM/VM





VM	einteilig	BH 7 BH 20	40-VM-07-00-200 40-VM-20-00-200	50-VM-07-00-200 50-VM-20-00-200	53-VM-07-00-200 53-VM-20-00-200	 ^{1*}
	einteilig gekröpft	BH 7	40-VM-07-25-200	50-VM-07-25-200	53-VM-07-25-200	 ^{2*}
	zweiteilig	BH 7	41-VM-07-00-200	51-VM-07-00-200	57-VM-07-00-200	 **
	zweiteilig gekröpft	BH 7	41-VM-07-25-200	51-VM-07-25-200	57-VM-07-25-00	 **
	zweiteilig variabel	BH 15	44-VM-15-00-200	54-VM-15-00-200	56-VM-15-00-200	 **

	Bauhöhe	Zero	QD	FM	Ansicht QD
--	---------	------	----	----	------------





S&B CONVEX

SB	einteilig	BH 8	40-SB-08-00-200	50-SB-08-00-200	53-SB-08-00-200	 ^{1*}
	einteilig gekröpft	BH 8	-	50-SB-08-25-200	-	 ^{2*}
	zweiteilig	BH 8	-	51-SB-08-00-200	-	 **
	zweiteilig gekröpft	BH 8	-	51-SB-08-25-200	-	 **

LM SCHIENE

LM	einteilig	BH 15	40-LM-15-00-200	50-LM-15-00-200	53-LM-15-00-200	 ^{1*}
	einteilig gekröpft	BH 15	40-LM-15-25-200	50-LM-15-25-200	53-LM-15-25-200	 ^{2*}
	zweiteilig	BH 15	41-LM-15-00-200	51-LM-15-00-200	57-LM-15-00-200	 **
	zweiteilig gekröpft	BH 15	41-LM-15-25-200	51-LM-15-25-200	57-LM-15-25-200	 **
	zweiteilig variabel	BH 20	44-LM-20-00-200	54-LM-20-00-200	56-LM-20-00-200	 **

PICATINNY / PICATINNY LONG

PT	einteilig	BH 20	40-PT-20-00-200	50-PT-20-00-200	53-PT-20-00-200	 ^{1*}
	einteilig gekröpft	BH 20	40-PT-20-25-200	50-PT-20-25-200	53-PT-20-25-200	 ^{2*}
	einteilig	BH 20	40-PT-20-60-200	50-PT-20-60-200	53-PT-20-60-200	 ^{1*} LONG
	zweiteilig variabel	BH 21	44-PT-21-00-200	54-PT-21-00-200	56-PT-21-00-200	 ^{2*} LONG

*Axialanschlag 5 mm (optional 3,8 mm) *Axial stop 5mm (optional 3,8 mm) | **Axialanschlag 3,8 mm **Axial stop 3,8 mm

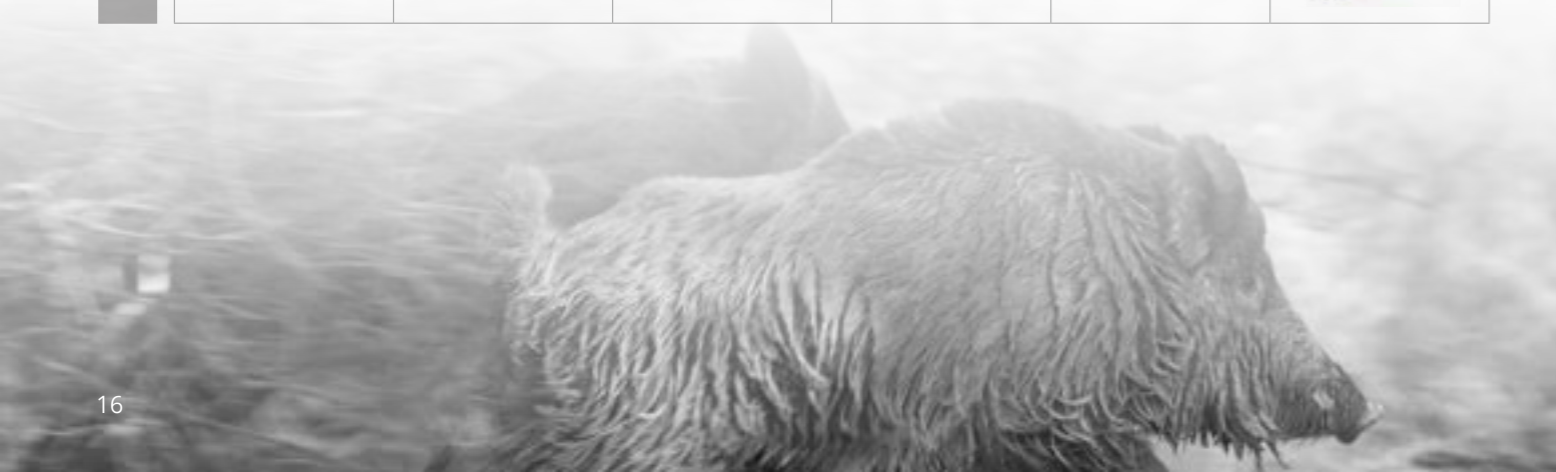



FÜR WEAVER/PICATINNY

FÜR WEAVER/PICATINNY (200)

	Bauhöhe	Zero	QD	FM	Ansicht QD
--	---------	------	----	----	------------

DOCTER | NOBLEX | GECO | LEICA TEMPUS | VORTEX | BURRIS FAST FIRE | KAHLES HELIA RD

DS	einteilig	BH 10	-	52-DS-10-00-200	-	
	einteilig slight	BH 5	-	52-DS-05-00-200	-	

AIMPOINT MICRO | HOLOSUN | GPO SPECTRA DOT

AM	einteilig slight	BH 5	-	52-AM-05-00-200	-	
----	------------------	------	---	-----------------	---	---

AIMPOINT ACRO

AC	Adapter	BH 7	-	24-AC-07	-	
----	---------	------	---	----------	---	---

*** Passend nur in Verbindung mit 52-AM-... *** Only suitable in combination with 52-AM-...

OPTOELEKTRONIK | OPTOELEKTRONIC

FÜR WEAVER/PICATINNY (200)

¹ Auch passend für Merkel Helix / Steel Action / Sako S20 / Benelli Lupo etc.; Achsmaß der Klemmelemente 110 mm



¹ Also fits Merkel Helix / Steel Action / Sako S20 / Benelli Lupo etc.; Axis dimension of clamp 110 mm

² Auch passend für Strasser / Benelli Argo etc.; Achsmaß der Klemmelemente 85 mm



² Also fits Strasser / Benelli Argo etc.; Axis dimension of clamp 85 mm

	Bauhöhe	Zero	QD	FM	Ansicht QD
--	---------	------	----	----	------------

PULSAR APEX | Digsight | Trail - YUKON Sightline N455S | Sightline N475S

PA	einteilig	BH 10	40-PA-10-00-200	50-PA-10-00-200	-	
	zweiteilig variabel	BH 17	44-PA-17-00-200	54-PA-17-00-200	-	



PULSAR Trail2 / LRF | Digsight Ultra N355 | Digsight Ultra N450 / LRF | Digsight Ultra N455 / LRF

PA2	einteilig	BH 10	40-PA2-10-00-200	50-PA2-10-00-200	-	
	zweiteilig variabel	BH 17	44-PA2-17-00-200	54-PA2-17-00-200	-	



FÜR WEAVER/PICATINNY (200)

	Bauhöhe	Zero	QD	FM	Ansicht QD
--	---------	------	----	----	------------



PULSAR Thermion I+II/Pro/LRF | Thermion Duo DXP50 | Duo DXP55 - INFIRAY Tube TL 35 | Tube TH 35 | Tube TH 50
LAHOUX Sight 35 - HIKMICRO Stellar SH 35 | SQ 35 | Stellar SH 50 | SQ 50 - NIGHT PEARL Marten TU 420 | Marten TU 430
Marten TU 450 | Marten TU 650 - GUIDE TU 420 | TU 430 | TU 450 | TU 620 | TU 630 | TU 650 - THERMTEC Ares 335 | 360 | 635 | 660

TH	einteilig	BH 24	40-TH-24-00-200	50-TH-24-00-200	-	
	zweiteilig variabel	BH 26	44-TH-26-00-200	54-TH-26-00-200	-	

PULSAR Digex N450 | N455 | C50 - INFIRAY Tube TD 50L | Tube TH 50 V2 - HIKMICRO Alpex A50T | A50TN

DE	einteilig	BH 27	40-DE-27-00-200	50-DE-27-00-200	-	
	zweiteilig variabel	BH 29	44-DE-29-00-200	54-DE-29-00-200	-	

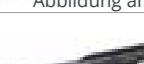

PULSAR Talion XQ38 | XG35

TN	einteilig	BH 10	40-TN-10-00-200	50-TN-10-00-200	-	
	einteilig	BH 16	40-TN-16-00-200	50-TN-16-00-200	-	
	zweiteilig variabel	BH 32	-	54-TN-23-00-200	-	

SHORT



*Abbildung ähnlich.

ATN Thor | Mars | X-Sight I + II

ATN	einteilig	BH 12	-	50-ATN-12-00-200*	-	
	zweiteilig variabel	BH 18	-	54-ATN-18-00-200*	-	

*Ab Objektivdurchmesser 70 mm Art.Nr. 24-ATN-10 mitbestellen.
*From an objective diameter of 70 mm, item no. order the 24-ATN-10 at the same time.

ATN4/5 Thor 4 | Thor LT | X-Sight 4K Pro | X-Sight LTV | X-Sight 4K INT

ATN4/5	einteilig	BH 24	40-ATN4-24-00-200	50-ATN4-24-00-200	-	
	zweiteilig variabel	BH 26	44-ATN4-26-00-200	54-ATN4-26-00-200	-	

*Axialanschlag 5 mm (optional 3,8 mm) *Axial stop 5mm (optional 3,8 mm) **Axialanschlag 3,8 mm **Axial stop 3,8 mm

FÜR WEAVER/PICATINNY (200)

¹ Auch passend für Merkel Helix / Steel Action / Sako S20 / Benelli Lupo etc.; Achsmaß der Klemmelemente 110 mm



¹ Also fits Merkel Helix / Steel Action / Sako S20 / Benelli Lupo etc.; Axis dimension of clamp 110 mm

² Auch passend für Strasser / Benelli Argo etc.; Achsmaß der Klemmelemente 85 mm

² Also fits Strasser / Benelli Argo etc.; Axis dimension of clamp 85 mm

	Bauhöhe	Zero	QD	FM	Ansicht QD
--	---------	------	----	----	------------

INFIRAY Xsight SH 50 | SL 50 - LIEMKE Sperber 50 | 64 - LAHOUX Scope Elite 50

IRX	einteilig		zweiteilig variabel		Ansicht QD
	BH	QD	BH	QD	
	BH 16	50-IRX-16-00-200	BH 17	54-IRX-17-00-200	 ^{1*}
	BH 17	54-IRX-17-00-200	BH 16	50-IRX-16-00-200	 ^{**}

INFIRAY Rico RH 35 | RH 50 | RL 42

IRR	einteilig		zweiteilig variabel		Ansicht QD
	BH	QD	BH	QD	
	BH 10	50-IRR-10-00-200	BH 17	54-IRR-17-00-200	 ^{1*}
	BH 17	54-IRR-17-00-200	BH 10	50-IRR-10-00-200	 ^{**}

INFIRAY Saim SCP 19 | SCL 35 | SCT 35 | SCH 50 | SCT 35 V2 - LIEMKE Sperber 19 | 25 | 35 NIGHT PEARL Fox 19 Hunt | Fox 35 Elite II | Fox 35 Hunt

IRS	einteilig		zweiteilig variabel		Ansicht QD
	BH	QD	BH	QD	
	BH 16	50-IRS-16-00-200	BH 17	54-IRS-17-00-200	 ^{1*}
	BH 17	54-IRS-17-00-200	BH 16	50-IRS-16-00-200	 ^{**}



INFIRAY Saim SCP 19 | SCL 35 | SCT 35 | SCH 50 | SCT 35 V2 - LIEMKE Sperber 19 | 25 | 35 NIGHT PEARL Fox 19 Hunt | Fox 35 Elite II | Fox 35 Hunt

IRM	einteilig		zweiteilig variabel		Ansicht QD
	BH	QD	BH	QD	
	BH 9	50-IRM-09-00-200	BH 17	54-IRM-17-00-200	 ^{1*} SHORT
	BH 17	54-IRM-17-00-200	BH 9	50-IRM-09-00-200	 ^{**}

INFIRAY CML 25



IRM	einteilig		zweiteilig variabel		Ansicht QD
	BH	QD	BH	QD	
	BH 13	50-IRM-13-00-200	BH 25	54-IRM-25-00-200	 ^{1*} SHORT
	BH 25	54-IRM-25-00-200	BH 13	50-IRM-13-00-200	 ^{**}

INFIRAY Tube TL25 SE | TL35 SE

SE	einteilig		zweiteilig variabel		Ansicht QD
	BH	QD	BH	QD	
	BH 34	40-SE-30-00-200	BH 36	44-SE-36-00-200	 ^{1*}
	BH 36	44-SE-36-00-200	BH 34	40-SE-30-00-200	 ^{**} Ansicht ZERO

	Bauhöhe	Zero	QD	FM	Ansicht QD
--	---------	------	----	----	------------



HIKMICRO Thunder TH 25 | TH 35 | TE 19 PRO | TE 25 PRO | TQ 35 PRO | TQ 50 PRO - Panther PH 35L | PH 50L | PQ 35L | PQ 50L Cheetah C32F-S | SL | SN | SNL

HMT	einteilig		zweiteilig variabel		Ansicht QD
	BH	QD	BH	QD	
	BH 10	50-HMT-10-00-200	BH 20	54-HMT-20-00-200	
BH 18	50-HMT-18-00-200	BH 18	44-HMT-18-00-200	 ^{1*}	
BH 20	54-HMT-20-00-200	BH 20	44-HMT-20-00-200	 ^{**}	



DEDAL HUNTER

DH	einteilig		zweiteilig variabel		Ansicht QD
	BH	QD	BH	QD	
BH 14	40-DH-14-00-200	BH 18	44-DH-18-00-200	 ^{1*}	
BH 18	44-DH-18-00-200	BH 14	40-DH-14-00-200	 ^{**}	

FORTUNA GENERAL

FG	einteilig		einteilig 40 mm gekröpft		Ansicht QD
	BH	QD	BH	QD	
BH 18	40-FG-18-00-200	BH 18	40-FG-18-40-200	 ^{1*}	
BH 18	40-FG-18-00-200	BH 18	40-FG-18-40-200	 ^{2*}	

FORTUNA GENERAL ONE

FG1	einteilig		einteilig 40 mm gekröpft		Ansicht QD
	BH	QD	BH	QD	
BH 14	40-FG1-14-00-200	BH 14	40-FG1-14-40-200	 ^{1*}	
BH 14	40-FG1-14-00-200	BH 14	40-FG1-14-40-200	 ^{2*}	

GSCI Wolfhound

GSWH	einteilig		zweiteilig variabel		Ansicht QD
	BH	QD	BH	QD	
BH 16	50-GSWH-16-00-200	BH 16	50-GSWH-16-00-200	 ^{1*}	
BH 16	50-GSWH-16-00-200	BH 16	50-GSWH-16-00-200	 ^{**}	

GUIDE TS 450

GT	einteilig		zweiteilig variabel		Ansicht QD
	BH	QD	BH	QD	
BH 17	50-GT-17-00-200	BH 23	54-GT-23-00-200	 ^{1*}	
BH 23	54-GT-23-00-200	BH 17	50-GT-17-00-200	 ^{**}	

*Axialanschlag 5 mm (optional 3,8 mm) *Axial stop 5mm (optional 3,8 mm) | **Axialanschlag 3,8 mm **Axial stop 3,8 mm

*Abbildung ähnlich.

FÜR **WEAVER/PICATINNY** (200)

¹ Auch passend für Merkel Helix / Steel Action / Sako S20 / Benelli Lupo etc.; Achsmaß der Klemmelemente 110 mm



¹ Also fits Merkel Helix / Steel Action / Sako S20 / Benelli Lupo etc.; Axis dimension of clamp 110 mm

² Auch passend für Strasser / Benelli Argo etc.; Achsmaß der Klemmelemente 85 mm



² Also fits Strasser / Benelli Argo etc.; Axis dimension of clamp 85 mm

	Bauhöhe	Zero	QD	FM	Ansicht QD
--	---------	------	----	----	------------



PARD NV008P | NV008P LRF | SA 19 | 25 | 35 | 45 LRF - SYTONG HT 60

PD	einteilig	BH 13	40-PD-13-00-200	50-PD-13-00-200	-		^{1*}
	zweiteilig variabel	BH 19	44-PD-19-00-200	54-PD-19-00-200	-		^{**}

PARD NV008S | NV008S LRF

PD2	einteilig	BH 13	40-PD2-13-00-200	50-PD2-13-00-200	-		^{1*}
	zweiteilig variabel	BH 19	44-PD2-19-00-200	54-PD2-19-00-200	-		^{**}

TVT ARCHER TSA

AR	einteilig	BH 13	-	50-AR-13-00-200	-		^{1*}
	zweiteilig variabel	BH 17	-	54-AR-17-00-200	-		^{**}

YUKON PHOTON

YP	zweiteilig variabel	BH 33	-	54-YP-33-00-200	-		^{**}
----	---------------------	-------	---	-----------------	---	---	---------------



FÜR WEAVER/PICATINNY (200)

¹ Auch passend für Merkel Helix / Steel Action / Sako S20 / Benelli Lupo etc.; Achsmaß der Klemmelemente 110 mm
¹ Also fits Merkel Helix / Steel Action / Sako S20 / Benelli Lupo etc.; Axis dimension of clamp 110 mm

² Auch passend für Strasser / Benelli Argo etc.; Achsmaß der Klemmelemente 85 mm
² Also fits Strasser / Benelli Argo etc.; Axis dimension of clamp 85 mm

	Bauhöhe	Zero	QD	FM	Ansicht QD
--	---------	------	----	----	------------

HIKMICRO THUNDER TE 19 PRO | TH 35C | TH 35 PC PRO | TQ 35C PRO | TQ 50 PRO

HST	einteilig	BH 12	45-HST-12-00-200	55-HST-12-00-200	-	
-----	-----------	-------	------------------	------------------	---	---

DIPOL TFA

DST	einteilig	BH 12	45-DST-12-00-200	55-DST-12-00-200	-	
-----	-----------	-------	------------------	------------------	---	---

LIEMKE MERLIN 35 | LUCHS 1 & 2

LST	einteilig	BH 12	45-LST-12-00-200	55-LST-12-00-200	-	
-----	-----------	-------	------------------	------------------	---	--

NIGHT PEARL SEER 35 & 50

NST	einteilig	BH 12	45-NST-12-00-200	55-NST-12-00-200	-	
-----	-----------	-------	------------------	------------------	---	---

GUIDE SENSMART TA435 | TA450 | BURRIS | JSA

GST	einteilig	BH 12	45-GST-12-00-200	55-GST-12-00-200	-	
-----	-----------	-------	------------------	------------------	---	---

GUN TEC OBERON

OST	einteilig	BH 12	45-OST-12-00-200	55-OST-12-00-200	-	
-----	-----------	-------	------------------	------------------	---	---

INFIRAY CML 25 | LIEMKE MERLIN 19 & 25

MST	einteilig	BH 12	45-MST-12-00-200	55-MST-12-00-200	-	
-----	-----------	-------	------------------	------------------	---	---

INFIRAY CL42 | CH50 V1 & V2 | MAL 25 & MAL 35 | MAH 50 | LIEMKE MERLIN 42 & 50

SST	einteilig	BH 12	45-SST-12-00-200	55-SST-12-00-200	-	
-----	-----------	-------	------------------	------------------	---	---

*Abbildung ähnlich.

*Axialanschlag 5 mm (optional 3,8 mm) *Axial stop 5mm (optional 3,8 mm) | **Axialanschlag 3,8 mm **Axial stop 3,8 mm



FÜR **BLASER**

FÜR BLASER (800)

	Bauhöhe	Zero	QD	FM	Ansicht QD
--	---------	------	----	----	------------

RINGMONTAGE 1"/26 MM

Ø 1"/26

einteilig	BH 14 BH 17 BH 20	40-26-14-00-800 40-26-17-00-800 40-26-20-00-800	50-26-14-00-800 50-26-17-00-800 50-26-20-00-800	53-26-14-00-800 53-26-17-00-800 53-26-20-00-800	
einteilig 20 MOA	BH 14 BH 17 BH 20	40-26-14-00-800-20MOA 40-26-17-00-800-20MOA 40-26-20-00-800-20MOA	50-26-14-00-800-20MOA 50-26-17-00-800-20MOA 50-26-20-00-800-20MOA	53-26-14-00-800-20MOA 53-26-17-00-800-20MOA 53-26-20-00-800-20MOA	
Ringe 20 mm nach vorne versetzt	BH 14 BH 17 BH 20	-	50-26-14-20-800 50-26-17-20-800 50-26-20-20-800	-	

RINGMONTAGE 30 MM

Ø 30

einteilig	BH 14 BH 17 BH 20 BH 23	40-30-14-00-800 40-30-17-00-800 40-30-20-00-800 40-30-23-00-800	50-30-14-00-800 50-30-17-00-800 50-30-20-00-800 50-30-23-00-800	53-30-14-00-800 53-30-17-00-800 53-30-20-00-800 53-30-23-00-800	
einteilig 20 MOA	BH 14 BH 17 BH 20 BH 23	40-30-14-00-800-20MOA 40-30-17-00-800-20MOA 40-30-20-00-800-20MOA 40-30-23-00-800-20MOA	50-30-14-00-800-20MOA 50-30-17-00-800-20MOA 50-30-20-00-800-20MOA 50-30-23-00-800-20MOA	53-30-14-00-800-20MOA 53-30-17-00-800-20MOA 53-30-20-00-800-20MOA 53-30-23-00-800-20MOA	
Ringe 20 mm nach vorne versetzt	BH 14 BH 17 BH 20 BH 23	-	50-30-14-20-800 50-30-17-20-800 50-30-20-20-800 50-30-23-20-800	-	

RINGMONTAGE 34 MM

Ø 34

einteilig	BH 14 BH 17 BH 20	40-34-14-00-800 40-34-17-00-800 40-34-20-00-800	50-34-14-00-800 50-34-17-00-800 50-34-20-00-800	53-34-14-00-800 53-34-17-00-800 53-34-20-00-800	
einteilig 20 MOA	BH 14 BH 17 BH 20	40-34-14-00-800-20MOA 40-34-17-00-800-20MOA 40-34-20-00-800-20MOA	50-34-14-00-800-20MOA 50-34-17-00-800-20MOA 50-34-20-00-800-20MOA	53-34-14-00-800-20MOA 53-34-17-00-800-20MOA 53-34-20-00-800-20MOA	
Ringe 20 mm nach vorne versetzt	BH 14 BH 17 BH 20	-	50-34-14-20-800 50-34-17-20-800 50-34-20-20-800	-	

RINGMONTAGE 35 MM

Ø 35

einteilig	BH 14 BH 17 BH 20	40-35-14-00-800 40-35-17-00-800 40-35-20-00-800	50-35-14-00-800 50-35-17-00-800 50-35-20-00-800	53-35-14-00-800 53-35-17-00-800 53-35-20-00-800	
einteilig 20 MOA	BH 14 BH 17 BH 20	40-35-14-00-800-20MOA 40-35-17-00-800-20MOA 40-35-20-00-800-20MOA	50-35-14-00-800-20MOA 50-35-17-00-800-20MOA 50-35-20-00-800-20MOA	53-35-14-00-800-20MOA 53-35-17-00-800-20MOA 53-35-20-00-800-20MOA	
Ringe 20 mm nach vorne versetzt	BH 14 BH 17 BH 20	-	50-35-14-20-800 50-35-17-20-800 50-35-20-20-800	-	

	Bauhöhe	Zero	QD	FM	Ansicht QD
--	---------	------	----	----	------------

RINGMONTAGE 36 MM

Ø 36

einteilig	BH 14 BH 17 BH 20	40-36-14-00-800 40-36-17-00-800 40-36-20-00-800	50-36-14-00-800 50-36-17-00-800 50-36-20-00-800	53-36-14-00-800 53-36-17-00-800 53-36-20-00-800	
einteilig 20 MOA	BH 14 BH 17 BH 20	40-36-14-00-800-20MOA 40-36-17-00-800-20MOA 40-36-20-00-800-20MOA	50-36-14-00-800-20MOA 50-36-17-00-800-20MOA 50-36-20-00-800-20MOA	53-36-14-00-800-20MOA 53-36-17-00-800-20MOA 53-36-20-00-800-20MOA	
Ringe 20 mm nach vorne versetzt	BH 14 BH 17 BH 20	-	50-36-14-20-800 50-36-17-20-800 50-36-20-20-800	-	

RINGMONTAGE 40 MM

Ø 40

einteilig	BH 14 BH 17 BH 20	40-40-14-00-800 40-40-17-00-800 40-40-20-00-800	50-40-14-00-800 50-40-17-00-800 50-40-20-00-800	53-40-14-00-800 53-40-17-00-800 53-40-20-00-800	
einteilig 20 MOA	BH 14 BH 17 BH 20	40-40-14-00-800-20MOA 40-40-17-00-800-20MOA 40-40-20-00-800-20MOA	50-40-14-00-800-20MOA 50-40-17-00-800-20MOA 50-40-20-00-800-20MOA	53-40-14-00-800-20MOA 53-40-17-00-800-20MOA 53-40-20-00-800-20MOA	
Ringe 20 mm nach vorne versetzt	BH 14 BH 17 BH 20	-	50-40-14-20-800 50-40-17-20-800 50-40-20-20-800	-	

SWAROVSKI SR (*Nicht für Z8i)

SR

einteilig	BH 10 BH 14 BH 20	40-SR-10-00-800* 40-SR-14-00-800 40-SR-20-00-800	50-SR-10-00-800 - 50-SR-20-00-800	53-SR-10-00-800 53-SR-14-00-800 53-SR-20-00-800	
-----------	-------------------------	--	---	---	--

ZEISS ZM/VM (*Nicht für V8)

VM

einteilig	BH 9 BH 14 BH 20	40-VM-09-00-800* 40-VM-14-00-800 40-VM-20-00-800	50-VM-09-00-800 - 50-VM-20-00-800	53-VM-09-00-800 53-VM-14-00-800 53-VM-20-00-800	
-----------	------------------------	--	---	---	--

S&B CONVEX

S&B

einteilig	BH 10	-	50-SB-10-00-800	-	
-----------	-------	---	-----------------	---	--

LM SCHIENE

LM

einteilig	BH 15	40-LM-15-00-800	50-LM-15-00-800	53-LM-15-00-800	
-----------	-------	-----------------	-----------------	-----------------	--

PICATINNY / PICATINNY LONG

PT

einteilig	BH 20	-	50-PT-20-00-800	-	
einteilig	BH 20	40-PT-20-100-800	50-PT-20-100-800	53-PT-20-100-800	
einteilig	BH 12	-	-	53-PT-12-00-800	

FÜR BLASER (800)

	Bauhöhe	Zero	QD	FM	Ansicht QD
--	---------	------	----	----	------------

DOCTER | NOBLEX | GECO | LEICA TEMPUS | VORTEX | BURRIS FAST FIRE | KAHLES HELIA RD

DS	einteilig slight long	BH 6	-	52-DS-06-00-800	-	
----	--------------------------	------	---	-----------------	---	---

AIMPOINT MICRO | HOLOSUN | GPO SPECTRA DOT

AM	einteilig slight long	BH 6	-	52-AM-06-00-800	-	
----	--------------------------	------	---	-----------------	---	---

PICATINNY

PT	einteilig slight long	BH 12	-	52-PT-12-00-800	-	
----	--------------------------	-------	---	-----------------	---	---

FÜR BLASER (800)

	Bauhöhe	Zero	QD	FM	Ansicht QD
--	---------	------	----	----	------------

PULSAR APEX | Digisight | Trail - YUKON Sightline N455S | Sightline N475S

PA	einteilig	BH 10	40-PA-10-00-800	50-PA-10-00-800	-	
----	-----------	-------	-----------------	-----------------	---	---

PULSAR Trail2 / LRF | Digisight Ultra N355 | Digisight Ultra N450 / LRF | Digisight Ultra N455 / LRF

PA2	einteilig	BH 10	40-PA2-10-00-800	50-PA2-10-00-800	-	
-----	-----------	-------	------------------	------------------	---	---

PULSAR Thermion I+II/Pro/LRF | Thermion Duo DXP50 | Duo DXP55 - INFIRAY Tube TL 35 | Tube TH 35 | Tube TH 50
 LAHOUX Sight 35 - HIKMICRO Stellar SH 35 | SQ 35 | Stellar SH 50 | SQ 50 - NIGHT PEARL Marten TU 420 | Marten TU 430
 Marten TU 450 | Marten TU 650 - GUIDE TU 420 | TU 430 | TU 450 | TU 620 | TU 630 | TU 650 - THERMTEC Ares 335 | 360 | 635 | 660

TH	einteilig	BH 20	40-TH-20-00-800	50-TH-20-00-800	-	
----	-----------	-------	-----------------	-----------------	---	---

PULSAR Digex N450 | N455 | C50 - INFIRAY Tube TD 50L | Tube TH 50 V2 - HIKMICRO Alpex A50T | A50TN

DE	einteilig	BH 23	40-DE-23-00-800	50-DE-23-00-800	-	
----	-----------	-------	-----------------	-----------------	---	---

PULSAR Talion XQ38 | XG35

TN	einteilig	BH 16	40-TN-16-00-800	50-TN-16-00-800	-	
----	-----------	-------	-----------------	-----------------	---	---

ATN Thor | Mars | X-Sight I + II

ATN	einteilig	BH 12	-	50-ATN-12-00-800*	-	
-----	-----------	-------	---	-------------------	---	---

*Ab Objektivdurchmesser 70 mm Art.Nr. 24-ATN-10 mitbestellen.
 *From an objective diameter of 70 mm, item no. order the 24-ATN-10 at the same time.

ATN4/5 Thor 4 | Thor LT | X-Sight 4K Pro | X-Sight LTV | X-Sight 4K INT

ATN4/5	einteilig	BH 24	40-ATN4-24-00-800	50-ATN4-24-00-800	-	
--------	-----------	-------	-------------------	-------------------	---	---



FÜR BLASER (800)

	Bauhöhe	Zero	QD	FM	Ansicht QD
--	---------	------	----	----	------------

INFIRAY Xsight SH 50 | SL 50 - **LIEMKE** Sperber 50 | 64 - **LAHOUX** Scope Elite 50

IRX	einteilig	BH 16	-	50-IRX-16-00-800	-	
-----	-----------	-------	---	------------------	---	--

INFIRAY Rico RH 35 | RH 50 | RL 42

IRR	einteilig	BH 10	40-IRR-10-00-800	50-IRR-10-00-800	-	
-----	-----------	-------	------------------	------------------	---	--

INFIRAY Saim SCP 19 | SCL 35 | SCT 35 | SCH 50 | SCT 35 V2 - **LIEMKE** Sperber 19 | 25 | 35
NIGHT PEARL Fox 19 Hunt | Fox 35 Elite II | Fox 35 Hunt

IRS	einteilig	BH 16	40-IRS-16-00-800	50-IRS-16-00-800	-	
-----	-----------	-------	------------------	------------------	---	--

INFIRAY Tube TL25 SE | TL35 SE

SE	einteilig	BH 30	40-SE-30-00-800	-	-	
----	-----------	-------	-----------------	---	---	--

HIKMICRO Thunder TH 25 | TH 35 | TE 19 PRO | TE 25 PRO | TQ 35 PRO | TQ 50 PRO - Panther PH 35L | PH 50L | PQ 35L | PQ 50L
Cheetah C32F-S | SL | SN | SNL

HMT	einteilig	BH 18	40-HMT-18-00-800	50-HMT-18-00-800	-	
-----	-----------	-------	------------------	------------------	---	--

DEDAL HUNTER

DH	einteilig	BH 14	40-DH-14-00-800	50-DH-14-00-800	-	
----	-----------	-------	-----------------	-----------------	---	--

FORTUNA GENERAL

FG	einteilig	BH 18	40-FG-18-00-800	50-FG-18-00-800	-	
----	-----------	-------	-----------------	-----------------	---	--

	Bauhöhe	Zero	QD	FM	Ansicht QD
--	---------	------	----	----	------------

FORTUNA GENERAL ONE

FG1	einteilig	BH 14	40-FG1-14-00-800	50-FG1-14-00-800	-	
-----	-----------	-------	------------------	------------------	---	--

GSCI Wolfhound

GSWH	einteilig	BH 16	-	50-GSWH-16-00-800	-	
------	-----------	-------	---	-------------------	---	--

GUIDE TS450

GT	einteilig	BH 17	-	50-GT-17-00-800	-	
----	-----------	-------	---	-----------------	---	--

PARD NV008P | NV008P LRF | SA 19 | 25 | 35 | 45 LRF - **SYTONG** HT 60

PD	einteilig	BH 13	40-PD-13-00-800	50-PD-13-00-800	-	
----	-----------	-------	-----------------	-----------------	---	--

PARD NV008S | NV008S LRF

PD2	einteilig	BH 13	40-PD2-13-00-800	50-PD2-13-00-800	-	
-----	-----------	-------	------------------	------------------	---	--



TVT ARCHER TSA

AR	einteilig	BH 13	-	50-AR-13-00-800	-	
----	-----------	-------	---	-----------------	---	--

YUKON PHOTON

YP	einteilig	BH 27	-	50-YP-27-00-800	-	
----	-----------	-------	---	-----------------	---	--

FÜR BLASER (800)

	Bauhöhe	Zero	QD	FM	Ansicht QD	
HIKMICRO THUNDER TE 19 PRO TH 35C TH 35 PC PRO TQ 35C PRO TQ 50 PRO						
HST	einteilig	BH 15	45-HST-15-00-800	55-HST-15-00-800	-	
DIPOL TFA						
DST	einteilig	BH 15	45-DST-15-00-800	55-DST-15-00-800	-	
LIEMKE MERLIN 35 LUCHS 1 & 2						
LST	einteilig	BH 15	45-LST-15-00-800	55-LST-15-00-800	-	
NIGHT PEARL SEER 35 & 50						
NST	einteilig	BH 15	45-NST-15-00-800	55-NST-15-00-800	-	
GUIDE SENSMART TA435 TA450 BURRIS JSA						
GST	einteilig	BH 15	45-GST-15-00-800	55-GST-15-00-800	-	
GUN TEC OBERON						
OST	einteilig	BH 15	45-OST-15-00-800	55-OST-15-00-800	-	
INFIRAY CML 25 LIEMKE MERLIN 19 & 25						
MST	einteilig	BH 15	45-MST-15-00-800	55-MST-15-00-800	-	
INFIRAY CL42 CH50 V1 & V2 MAL 25 & MAL 35 MAH 50 LIEMKE MERLIN 42 & 50						
SST	einteilig	BH 15	45-SST-15-00-800	55-SST-15-00-800	-	

*Abbildung ähnlich.



FÜR **SAUER 404**

FÜR SAUER 404 (650) Neues Modell Sauer 303 - SN: L....

	Bauhöhe	Zero	QD	FM	Ansicht QD
--	---------	------	----	----	------------

RINGMONTAGE 1"/26 MM

Ø 1"/26	einteilig	BH 14 BH 17 BH 20	40-26-14-00-650 40-26-17-00-650 40-26-20-00-650	50-26-14-00-650 50-26-17-00-650 50-26-20-00-650	53-26-14-00-650 53-26-17-00-650 53-26-20-00-650	
---------	-----------	-------------------------	---	---	---	---

RINGMONTAGE 30 MM

Ø 30	einteilig	BH 14 BH 17 BH 20 BH 23	40-30-14-00-650 40-30-17-00-650 40-30-20-00-650 40-30-23-00-650	50-30-14-00-650 50-30-17-00-650 50-30-20-00-650 50-30-23-00-650	53-30-14-00-650 53-30-17-00-650 53-30-20-00-650 53-30-23-00-650	
------	-----------	----------------------------------	--	--	--	---

RINGMONTAGE 34 MM

Ø 34	einteilig	BH 14 BH 17 BH 20	40-34-14-00-650 40-34-17-00-650 40-34-20-00-650	50-34-14-00-650 50-34-17-00-650 50-34-20-00-650	53-34-14-00-650 53-34-17-00-650 53-34-20-00-650	
------	-----------	-------------------------	---	---	---	---

RINGMONTAGE 35 MM

Ø 35	einteilig	BH 14 BH 17 BH 20	40-35-14-00-650 40-35-17-00-650 40-35-20-00-650	50-35-14-00-650 50-35-17-00-650 50-35-20-00-650	53-35-14-00-650 53-35-17-00-650 53-35-20-00-650	
------	-----------	-------------------------	---	---	---	---

RINGMONTAGE 36 MM

Ø 36	einteilig	BH 14 BH 17 BH 20	40-36-14-00-650 40-36-17-00-650 40-36-20-00-650	50-36-14-00-650 50-36-17-00-650 50-36-20-00-650	53-36-14-00-650 53-36-17-00-650 53-36-20-00-650	
------	-----------	-------------------------	---	---	---	---

RINGMONTAGE 40 MM

Ø 40	einteilig	BH 14 BH 17 BH 20	40-40-14-00-650 40-40-17-00-650 40-40-20-00-650	50-40-14-00-650 50-40-17-00-650 50-40-20-00-650	53-40-14-00-650 53-40-17-00-650 53-40-20-00-650	
------	-----------	-------------------------	---	---	---	---

	Bauhöhe	Zero	QD	FM	Ansicht QD
--	---------	------	----	----	------------

SWAROVSKI SR

SR	einteilig	BH 9	40-SR-09-00-650	50-SR-09-00-650	53-SR-09-00-650	
----	-----------	------	-----------------	-----------------	-----------------	---

ZEISS ZM/VM

VM	einteilig	BH 8	40-VM-08-00-650	50-VM-08-00-650	53-VM-08-00-650	
----	-----------	------	-----------------	-----------------	-----------------	---



S&B CONVEX

S&B	einteilig	BH 9	-	50-SB-09-00-650	-	
-----	-----------	------	---	-----------------	---	---

LM SCHIENE

LM	einteilig	BH 15	40-LM-15-00-650	50-LM-15-00-650	53-LM-15-00-650	
----	-----------	-------	-----------------	-----------------	-----------------	---

PICATINNY / PICATINNY LONG

PT	einteilig	BH 20	40-PT-20-00-650	50-PT-20-00-650	53-PT-20-00-650	
	einteilig	BH 20	40-PT-20-70-650	50-PT-20-70-650	53-PT-20-70-650	

FÜR SAUER 404

FÜR SAUER 404 (650) Neues Modell Sauer 303 - SN: L....

	Bauhöhe	Zero	QD	FM	Ansicht QD
--	---------	------	----	----	------------

DOCTER | NOBLEX | GECO | LEICA TEMPUS | VORTEX | BURRIS FAST FIRE | KAHLES HELIA RD

DS	einteilig slight long	BH 6	-	52-DS-06-00-650	-	
----	--------------------------	------	---	-----------------	---	---

AIMPOINT MICRO | HOLOSUN | GPO SPECTRA DOT

AM	einteilig slight long	BH 6	-	52-AM-06-00-650	-	
----	--------------------------	------	---	-----------------	---	---

PICATINNY

PT	einteilig slight long	BH 12	-	52-PT-12-00-650	-	
----	--------------------------	-------	---	-----------------	---	---

FÜR SAUER 404 (650) Neues Modell Sauer 303 - SN: L....

	Bauhöhe	Zero	QD	FM	Ansicht QD
--	---------	------	----	----	------------

PULSAR APEX | Digisight | Trail - YUKON Sightline N455S | Sightline N475S

PA	einteilig	BH 10	40-PA-10-00-650	50-PA-10-00-650	-	
----	-----------	-------	-----------------	-----------------	---	---

PULSAR Trail2 / LRF | Digisight Ultra N355 | Digisight Ultra N450 / LRF | Digisight Ultra N455 / LRF

PA2	einteilig	BH 10	40-PA2-10-00-650	50-PA2-10-00-650	-	
-----	-----------	-------	------------------	------------------	---	---

PULSAR Thermion I+II/Pro/LRF | Thermion Duo DXP50 | Duo DXP55 - INFIRAY Tube TL 35 | Tube TH 35 | Tube TH 50
 LAHOUX Sight 35 - HIKMICRO Stellar SH 35 | SQ 35 | Stellar SH 50 | SQ 50 - NIGHT PEARL Marten TU 420 | Marten TU 430
 Marten TU 450 | Marten TU 650 - GUIDE TU 420 | TU 430 | TU 450 | TU 620 | TU 630 | TU 650 - THERMTEC Ares 335 | 360 | 635 | 660

TH	einteilig	BH 24	40-TH-24-00-650	50-TH-24-00-650	-	
----	-----------	-------	-----------------	-----------------	---	---

PULSAR Digex N450 | N455 | C50 - INFIRAY Tube TD 50L | Tube TH 50 V2 - HIKMICRO Alpex A50T | A50TN

DE	einteilig	BH 27	40-DE-27-00-650	50-DE-27-00-650	-	
----	-----------	-------	-----------------	-----------------	---	---

PULSAR Talion XQ38 | XG35

TN	einteilig	BH 16	40-TN-16-00-650	50-TN-16-00-650	-	 *Abbildung ähnlich.
----	-----------	-------	-----------------	-----------------	---	--

ATN Thor | Mars | X-Sight I + II

ATN	einteilig	BH 12	-	50-ATN-12-00-650*	-	
-----	-----------	-------	---	-------------------	---	---

*Ab Objektivdurchmesser 70 mm Art.Nr. 24-ATN-10 mitbestellen.
 *From an objective diameter of 70 mm, item no. order the 24-ATN-10 at the same time.

ATN4/5 Thor 4 | Thor LT | X-Sight 4K Pro | X-Sight LTV | X-Sight 4K INT

ATN4/5	einteilig	BH 24	40-ATN4-24-00-650	50-ATN4-24-00-650	-	
--------	-----------	-------	-------------------	-------------------	---	---

INFIRAY Xsight SH 50 | SL 50 - LIEMKE Sperber 50 | 64 - LAHOUX Scope Elite 50

IRX	einteilig	BH 16	-	50-IRX-16-00-650	-	
-----	-----------	-------	---	------------------	---	---

FÜR SAUER 404 (650) Neues Modell Sauer 303 - SN: L....

	Bauhöhe	Zero	QD	FM	Ansicht QD
--	---------	------	----	----	------------

INFIRAY Rico RH 35 | RH 50 | RL 42

IRR	einteilig	BH 10	40-IRR-10-00-650	50-IRR-10-00-650	-	
-----	-----------	-------	------------------	------------------	---	---

INFIRAY Saim SCP 19 | SCL 35 | SCT 35 | SCH 50 | SCT 35 V2 - **LIEMKE** Sperber 19 | 25 | 35
NIGHT PEARL Fox 19 Hunt | Fox 35 Elite II | Fox 35 Hunt

IRS	einteilig	BH 16	40-IRS-16-00-650	50-IRS-16-00-650	-	
-----	-----------	-------	------------------	------------------	---	---

*Abbildung ähnlich.

HIKMICRO Thunder TH 25 | TH 35 | TE 19 PRO | TE 25 PRO | TQ 35 PRO | TQ 50 PRO - Panther PH 35L | PH 50L | PQ 35L | PQ 50L
Cheetah C32F-S | SL | SN | SNL

HMT	einteilig	BH 18	40-HMT-18-00-650	50-HMT-18-00-650	-	
-----	-----------	-------	------------------	------------------	---	---

DEDAL HUNTER

DH	einteilig	BH 14	-	50-DH-14-00-650	-	
----	-----------	-------	---	-----------------	---	---

GUIDE TS 450

GT	einteilig	BH 17	-	50-GT-17-00-650	-	
----	-----------	-------	---	-----------------	---	---

PARD NV008P | NV008P LRF | SA 19 | 25 | 35 | 45 LRF - SYTONG HT 60

PD	einteilig	BH 13	40-PD-13-00-650	50-PD-13-00-650	-	
----	-----------	-------	-----------------	-----------------	---	---

PARD NV008S | NV008S LRF

PD2	einteilig	BH 13	40-PD2-13-00-650	50-PD2-13-00-650	-	
-----	-----------	-------	------------------	------------------	---	---

YUKON PHOTON

YP	einteilig	BH 27	-	50-YP-27-00-650	-	
----	-----------	-------	---	-----------------	---	---



FÜR SAUER 404

FÜR SAUER 404 (650) Neues Modell Sauer 303 - SN: L....



	Bauhöhe	Zero	QD	FM	Ansicht QD
--	---------	------	----	----	------------

HIKMICRO THUNDER TE 19 PRO | TH 35C | TH 35 PC PRO | TQ 35C PRO | TQ 50 PRO

HST	einteilig	BH 15	45-HST-15-00-650	55-HST-15-00-650	-	
-----	-----------	-------	------------------	------------------	---	--

DIPOL TFA

DST	einteilig	BH 15	45-DST-15-00-650	55-DST-15-00-650	-	
-----	-----------	-------	------------------	------------------	---	--

LIEMKE MERLIN 35 | LUCHS 1 & 2

LST	einteilig	BH 15	45-LST-15-00-650	55-LST-15-00-650	-	
-----	-----------	-------	------------------	------------------	---	--

NIGHT PEARL SEER 35 & 50

NST	einteilig	BH 15	45-NST-15-00-650	55-NST-15-00-650	-	
-----	-----------	-------	------------------	------------------	---	--

GUIDE SENSMART TA435 | TA450 | BURRIS | JSA

GST	einteilig	BH 15	45-GST-15-00-650	55-GST-15-00-650	-	
-----	-----------	-------	------------------	------------------	---	--

GUN TEC OBERON

OST	einteilig	BH 15	45-OST-15-00-650	55-OST-15-00-650	-	
-----	-----------	-------	------------------	------------------	---	--

INFIRAY CML 25 | LIEMKE MERLIN 19 & 25

MST	einteilig	BH 15	45-MST-15-00-650	55-MST-15-00-650	-	
-----	-----------	-------	------------------	------------------	---	--

INFIRAY CL42 | CH50 V1 & V2 | MAL 25 & MAL 35 | MAH 50 | LIEMKE MERLIN 42 & 50

SST	einteilig	BH 15	45-SST-15-00-650	55-SST-15-00-650	-	
-----	-----------	-------	------------------	------------------	---	--

*Abbildung ähnlich.



FÜR SAUER 303

FÜR SAUER 303 (600)

Altes Modell Seriennummer: R....
Neues Modell Seriennummer L.... siehe ab Seite 12 / Sauer 404

	Bauhöhe	Zero	QD	FM	Ansicht QD
--	---------	------	----	----	------------

RINGMONTAGE 1 1/26 MM

Ø 1 1/26	einteilig	BH 14	-	50-26-14-00-600 50-26-17-00-600 50-26-20-00-600	-	
		BH 17 BH 20				

RINGMONTAGE 30 MM

Ø 30	einteilig	BH 14	-	50-30-14-00-600 50-30-17-00-600 50-30-20-00-600 50-30-23-00-600	-	
		BH 17 BH 20 BH 23				

RINGMONTAGE 34 MM

Ø 34	einteilig	BH 14	-	50-34-14-00-600 50-34-17-00-600 50-34-20-00-600	-	
		BH 17 BH 20				

RINGMONTAGE 35 MM

Ø 35	einteilig	BH 14	-	50-35-14-00-600 50-35-17-00-600 50-35-20-00-600	-	
		BH 17 BH 20				

RINGMONTAGE 36 MM

Ø 36	einteilig	BH 14	-	50-36-14-00-600 50-36-17-00-600 50-36-20-00-600	-	
		BH 17 BH 20				

RINGMONTAGE 40 MM

Ø 40	einteilig	BH 14	-	50-40-14-00-600 50-40-17-00-600 50-40-20-00-600	-	
		BH 17 BH 20				

	Bauhöhe	Zero	QD	FM	Ansicht QD
--	---------	------	----	----	------------

SWAROVSKI SR

SR	einteilig	BH 9	40-SR-09-00-600	50-SR-09-00-600	53-SR-09-00-600	

ZEISS ZM/VM

VM	einteilig	BH 8	40-VM-08-00-600	50-VM-08-00-600	53-VM-08-00-600	

S&B CONVEX

S&B	einteilig	BH 9	-	50-SB-09-00-600	-	

LM SCHIENE

LM	einteilig	BH 15	-	50-LM-15-00-600	-	

PICATINNY LONG

PT	einteilig	BH 20	-	50-PT-20-70-600	-	

FÜR SAUER 303

FÜR SAUER 303 (600) Altes Modell Seriennummer: R....
Neues Modell Seriennummer L.... siehe ab Seite 12 / Sauer 404

	Bauhöhe	Zero	QD	FM	Ansicht QD
--	---------	------	----	----	------------

DOCTER | NOBLEX | GECO | LEICA TEMPUS | VORTEX | BURRIS FAST FIRE | KAHLES HELIA RD

DS	einteilig slight	BH 4	-	52-DS-04-00-600	-	
----	---------------------	------	---	-----------------	---	---

AIMPOINT MICRO | HOLOSUN | GPO SPECTRA DOT

AM	einteilig slight	BH 4	-	52-AM-04-00-600	-	
----	---------------------	------	---	-----------------	---	---

FÜR SAUER 303 (600) Altes Modell Seriennummer: R....
Neues Modell Seriennummer L.... siehe ab Seite 12 / Sauer 404

	Bauhöhe	Zero	QD	FM	Ansicht QD
--	---------	------	----	----	------------

PULSAR APEX | Digisight | Trail - YUKON Sightline N455S | Sightline N475S

PA	einteilig	BH 10	40-PA-10-00-600	50-PA-10-00-600	-	
----	-----------	-------	-----------------	-----------------	---	---

PULSAR Trail2 / LRF | Digisight Ultra N355 | Digisight Ultra N450 / LRF | Digisight Ultra N455 / LRF

PA2	einteilig	BH 10	40-PA2-10-00-600	50-PA2-10-00-600	-	
-----	-----------	-------	------------------	------------------	---	---

PULSAR Thermion I+II/Pro/LRF | Thermion Duo DXP50 | Duo DXP55 - INFIRAY Tube TL 35 | Tube TH 35 | Tube TH 50
LAHOUX Sight 35 - HIKMICRO Stellar SH 35 | SQ 35 | Stellar SH 50 | SQ 50 - NIGHT PEARL Marten TU 420 | Marten TU 430
Marten TU 450 | Marten TU 650 - GUIDE TU 420 | TU 430 | TU 450 | TU 620 | TU 630 | TU 650 - THERMTEC Ares 335 | 360 | 635 | 660

TH	einteilig	BH 24	40-TH-24-00-600	50-TH-24-00-600	-	
----	-----------	-------	-----------------	-----------------	---	---

PULSAR Digex N450 | N455 | C50 - INFIRAY Tube TD 50L | Tube TH 50 V2 - HIKMICRO Alpex A50T | A50TN

DE	einteilig	BH 27	40-DE-27-00-600	50-DE-27-00-600	-	
----	-----------	-------	-----------------	-----------------	---	---

ATN Thor | Mars | X-Sight I + II

ATN	einteilig	BH 12	-	50-ATN-12-00-600*	-	
-----	-----------	-------	---	-------------------	---	---

*Ab Objektivdurchmesser 70 mm Art.Nr. 24-ATN-10 mitbestellen.
*From an objective diameter of 70 mm, item no. order the 24-ATN-10 at the same time.

ATN4/5 Thor 4 | Thor LT | X-Sight 4K Pro | X-Sight LTV | X-Sight 4K INT

ATN4/5	einteilig	BH 24	40-ATN4-24-00-600	50-ATN4-24-00-600	-	
--------	-----------	-------	-------------------	-------------------	---	---

YUKON PHOTON

YP	einteilig	BH 27	-	50-YP-27-00-600	-	
----	-----------	-------	---	-----------------	---	---

*Abbildung ähnlich.

DEDAL HUNTER

DH	einteilig	BH 14	-	50-DH-14-00-600	-	
----	-----------	-------	---	-----------------	---	---

FÜR SAUER 303 (600) Altes Modell Seriennummer: R....
Neues Modell Seriennummer L.... siehe ab Seite 12 / Sauer 404

	Bauhöhe	Zero	QD	FM	Ansicht QD
--	---------	------	----	----	------------

TVT ARCHER TSA

AR	einteilig	BH 13	-	50-AR-13-00-600	-	
----	-----------	-------	---	-----------------	---	--

PARD NV008P | NV008P LRF | SA 19 | 25 | 35 | 45 LRF - SYTONG HT 60

PD	einteilig	BH 13	-	50-PD-13-00-600	-	
----	-----------	-------	---	-----------------	---	--

PARD NV008S | NV008S LRF

PD2	einteilig	BH 13	40-PD2-13-00-600	50-PD2-13-00-600	-	
-----	-----------	-------	------------------	------------------	---	--

GUIDE TS 450

GT	einteilig	BH 17	-	50-GT-17-00-600	-	
----	-----------	-------	---	-----------------	---	--

INFIRAY Rico RH 35 | RH 50 | RL 42

IRR	einteilig	BH 10	40-IRR-10-00-600	-	-	
-----	-----------	-------	------------------	---	---	--

INFIRAY Saim SCP 19 | SCL 35 | SCT 35 | SCH 50 | SCT 35 V2 - LIEMKE Sperber 19 | 25 | 35
NIGHT PEARL Fox 19 Hunt | Fox 35 Elite II | Fox 35 Hunt

IRS	einteilig	BH 16	40-IRS-16-00-600	50-IRS-16-00-600	-	
-----	-----------	-------	------------------	------------------	---	--

*Abbildung ähnlich.

HIKMICRO Thunder TH 25 | TH 35 | TE 19 PRO | TE 25 PRO | TQ 35 PRO | TQ 50 PRO - Panther PH 35L | PH 50L | PQ 35L | PQ 50L
Cheetah C32F-S | SL | SN | SNL

HMT	einteilig	BH 18	40-HMT-18-00-600	50-HMT-18-00-600	-	
-----	-----------	-------	------------------	------------------	---	--



FÜR **TIKKA T3/T3x**

FÜR TIKKA T3 / T3x (400)

	Bauhöhe	Zero	QD	FM	Ansicht QD
--	---------	------	----	----	------------

RINGMONTAGE 1"/26 MM

Ø 1"/26	einteilig	BH 16 BH 19 BH 22	40-26-16-00-400 40-26-19-00-400 40-26-22-00-400	50-26-16-00-400 50-26-19-00-400 50-26-22-00-400	53-26-16-00-400 53-26-19-00-400 53-26-22-00-400	
---------	-----------	-------------------------	---	---	---	---

RINGMONTAGE 30 MM

Ø 30	einteilig	BH 16 BH 19 BH 22 BH 25	40-30-16-00-400 40-30-19-00-400 40-30-22-00-400 40-30-25-00-400	50-30-16-00-400 50-30-19-00-400 50-30-22-00-400 50-30-25-00-400	53-30-16-00-400 53-30-19-00-400 53-30-22-00-400 53-30-25-00-400	
------	-----------	----------------------------------	--	--	--	---

RINGMONTAGE 34 MM

Ø 34	einteilig	BH 16 BH 19 BH 22	40-34-16-00-400 40-34-19-00-400 40-34-22-00-400	50-34-16-00-400 50-34-19-00-400 50-34-22-00-400	53-34-16-00-400 53-34-19-00-400 53-34-22-00-400	
------	-----------	-------------------------	---	---	---	---

RINGMONTAGE 35 MM

Ø 35	einteilig	BH 16 BH 19 BH 22	40-35-16-00-400 40-35-19-00-400 40-35-22-00-400	50-35-16-00-400 50-35-19-00-400 50-35-22-00-400	53-35-16-00-400 53-35-19-00-400 53-35-22-00-400	
------	-----------	-------------------------	---	---	---	---

RINGMONTAGE 36 MM

Ø 36	einteilig	BH 16 BH 19 BH 22	40-36-16-00-400 40-36-19-00-400 40-36-22-00-400	50-36-16-00-400 50-36-19-00-400 50-36-22-00-400	53-36-16-00-400 53-36-19-00-400 53-36-22-00-400	
------	-----------	-------------------------	---	---	---	---

RINGMONTAGE 40 MM

Ø 40	einteilig	BH 16 BH 19 BH 22	40-40-16-00-400 40-40-19-00-400 40-40-22-00-400	50-40-16-00-400 50-40-19-00-400 50-40-22-00-400	53-40-16-00-400 53-40-19-00-400 53-40-22-00-400	
------	-----------	-------------------------	---	---	---	---

	Bauhöhe	Zero	QD	FM	Ansicht QD
--	---------	------	----	----	------------

SWAROVSKI SR

SR	einteilig	BH 10	40-SR-10-00-400	50-SR-10-00-400	53-SR-10-00-400	
----	-----------	-------	-----------------	-----------------	-----------------	---

ZEISS ZM/VM

VM	einteilig	BH 9	40-VM-09-00-400	50-VM-09-00-400	53-VM-09-00-400	
----	-----------	------	-----------------	-----------------	-----------------	---



S&B CONVEX

S&B	einteilig	BH 10	-	50-SB-10-00-400	-	
-----	-----------	-------	---	-----------------	---	---

LM SCHIENE

LM	einteilig	BH 17	40-LM-17-00-400	50-LM-17-00-400	53-LM-17-00-400	
----	-----------	-------	-----------------	-----------------	-----------------	---

PICATINNY / PICATINNY LONG

PT	einteilig	BH 20	-	50-PT-20-00-400	-	
	einteilig	BH 20	-	50-PT-20-60-400	-	

*Abbildung ähnlich.

FÜR
TIKKA T3/T3x

FÜR TIKKA T3 / T3X (400)

	Bauhöhe	Zero	QD	FM	Ansicht QD
--	---------	------	----	----	------------

DOCTER | NOBLEX | GECO | LEICA TEMPUS | VORTEX | BURRIS FAST FIRE | KAHLES HELIA RD

DS	einteilig sight	BH 5	-	52-DS-05-00-400	-	
----	--------------------	------	---	-----------------	---	---

AIMPOINT MICRO | HOLOSUN | GPO SPECTRA DOT

AM	einteilig sight	BH 5	-	52-AM-05-00-400	-	
----	--------------------	------	---	-----------------	---	---

FÜR TIKKA T3 / T3X (400)

	Bauhöhe	Zero	QD	FM	Ansicht QD
--	---------	------	----	----	------------

PULSAR APEX | Digisight | Trail - YUKON Sightline N455S | Sightline N475S

PA	einteilig	BH 10	40-PA-10-00-400	50-PA-10-00-400	-	
----	-----------	-------	-----------------	-----------------	---	---

PULSAR Trail2 / LRF | Digisight Ultra N355 | Digisight Ultra N450 / LRF | Digisight Ultra N455 / LRF

PA2	einteilig	BH 10	40-PA2-10-00-400	50-PA2-10-00-400	-	
-----	-----------	-------	------------------	------------------	---	---

PULSAR Thermion I+II/Pro/LRF | Thermion Duo DXP50 | Duo DXP55 - INFIRAY Tube TL 35 | Tube TH 35 | Tube TH 50
 LAHOUX Sight 35 - HIKMICRO Stellar SH 35 | SQ 35 | Stellar SH 50 | SQ 50 - NIGHT PEARL Marten TU 420 | Marten TU 430
 Marten TU 450 | Marten TU 650 - GUIDE TU 420 | TU 430 | TU 450 | TU 620 | TU 630 | TU 650 - THERMTEC Ares 335 | 360 | 635 | 660

TH	einteilig	BH 24	40-TH-24-00-400	50-TH-24-00-400	-	
----	-----------	-------	-----------------	-----------------	---	---

PULSAR Digex N450 | N455 | C50 - INFIRAY Tube TD 50L | Tube TH 50 V2 - HIKMICRO Alpex A50T | A50TN

DE	einteilig	BH 27	40-DE-27-00-400	50-DE-27-00-400	-	
----	-----------	-------	-----------------	-----------------	---	---

ATN Thor | Mars | X-Sight I + II

ATN	einteilig	BH 12	-	50-ATN-12-00-400*	-	
-----	-----------	-------	---	-------------------	---	---

*Ab Objektivdurchmesser 70 mm Art.Nr. 24-ATN-10 mitbestellen.
 *From an objective diameter of 70 mm, item no. order the 24-ATN-10 at the same time.

ATN4/5 Thor 4 | Thor LT | X-Sight 4K Pro | X-Sight LTV | X-Sight 4K INT

ATN4/5	einteilig	BH 24	40-ATN4-24-00-400	50-ATN4-24-00-400	-	
--------	-----------	-------	-------------------	-------------------	---	---

YUKON PHOTON

YP	einteilig	BH 27	-	50-YP-27-00-400	-	
----	-----------	-------	---	-----------------	---	---

DEDAL HUNTER

DH	einteilig	BH 14	-	50-DH-14-00-400	-	
----	-----------	-------	---	-----------------	---	---



FÜR TIKKA T3 / T3X (400)

	Bauhöhe	Zero	QD	FM	Ansicht QD
--	---------	------	----	----	------------

TVT ARCHER TSA

AR	einteilig	BH 13	-	50-AR-13-00-400	-	
----	-----------	-------	---	-----------------	---	---

PARD NV008P | NV008P LRF | SA 19 | 25 | 35 | 45 LRF - SYTONG HT 60

PD	einteilig	BH 13	40-PD-13-00-400	50-PD-13-00-400	-	
----	-----------	-------	-----------------	-----------------	---	---

PARD NV008S | NV008S LRF

PD2	einteilig	BH 13	40-PD2-13-00-400	50-PD2-13-00-400	-	
-----	-----------	-------	------------------	------------------	---	---

GUIDE TS 450

GT	einteilig	BH 17	-	50-GT-17-00-400	-	
----	-----------	-------	---	-----------------	---	---

INFIRAY Rico RH 35 | RH 50 | RL 42

IRR	einteilig	BH 10	40-IRR-10-00-400	50-IRR-10-00-400	-	
-----	-----------	-------	------------------	------------------	---	---

INFIRAY Saim SCP 19 | SCL 35 | SCT 35 | SCH 50 | SCT 35 V2 - LIEMKE Sperber 19 | 25 | 35 NIGHT PEARL Fox 19 Hunt | Fox 35 Elite II | Fox 35 Hunt

IRS	einteilig	BH 16	40-IRS-16-00-400	50-IRS-16-00-400	-	
-----	-----------	-------	------------------	------------------	---	---

*Abbildung ähnlich.

HIKMICRO Thunder TH 25 | TH 35 | TE 19 PRO | TE 25 PRO | TQ 35 PRO | TQ 50 PRO - Panther PH 35L | PH 50L | PQ 35L | PQ 50L Cheetah C32F-S | SL | SN | SNL

HMT	einteilig	BH 18	40-HMT-18-00-400	50-HMT-18-00-400	-	
-----	-----------	-------	------------------	------------------	---	---



FÜR **CZ 550/557**

FÜR **CZ 550/557** (520)

	Bauhöhe	Zero	QD	FM	Ansicht QD
--	---------	------	----	----	------------

RINGMONTAGE 1"/26 MM

Ø 1"/26	einteilig	BH 16	40-26-16-00-520	50-26-16-00-520	53-26-16-00-520	
		BH 19	40-26-19-00-520	50-26-19-00-520	53-26-19-00-520	
		BH 22	40-26-22-00-520	50-26-22-00-520	53-26-22-00-520	

RINGMONTAGE 30 MM

Ø 30	einteilig	BH 16	40-30-16-00-520	50-30-16-00-520	53-30-16-00-520	
		BH 19	40-30-19-00-520	50-30-19-00-520	53-30-19-00-520	
		BH 22	40-30-22-00-520	50-30-22-00-520	53-30-22-00-520	
		BH 25	40-30-25-00-520	50-30-25-00-520	53-30-25-00-520	

RINGMONTAGE 34 MM

Ø 34	einteilig	BH 16	40-34-16-00-520	50-34-16-00-520	53-34-16-00-520	
		BH 19	40-34-19-00-520	50-34-19-00-520	53-34-19-00-520	
		BH 22	40-34-22-00-520	50-34-22-00-520	53-34-22-00-520	

RINGMONTAGE 35 MM

Ø 35	einteilig	BH 16	40-35-16-00-520	50-35-16-00-520	53-35-16-00-520	
		BH 19	40-35-19-00-520	50-35-19-00-520	53-35-19-00-520	
		BH 22	40-35-22-00-520	50-35-22-00-520	53-35-22-00-520	

RINGMONTAGE 36 MM

Ø 36	einteilig	BH 16	40-36-16-00-520	50-36-16-00-520	53-36-16-00-520	
		BH 19	40-36-19-00-520	50-36-19-00-520	53-36-19-00-520	
		BH 22	40-36-22-00-520	50-36-22-00-520	53-36-22-00-520	

RINGMONTAGE 40 MM

Ø 40	einteilig	BH 16	40-40-16-00-520	50-40-16-00-520	53-40-16-00-520	
		BH 19	40-40-19-00-520	50-40-19-00-520	53-40-19-00-520	
		BH 22	40-40-22-00-520	50-40-22-00-520	53-40-22-00-520	

	Bauhöhe	Zero	QD	FM	Ansicht QD
--	---------	------	----	----	------------

SWAROVSKI SR

SR	einteilig	BH 10	40-SR-10-00-520	50-SR-10-00-520	53-SR-10-00-520	

ZEISS ZM/VM

VM	einteilig	BH 9	-	50-VM-09-00-520	-	



S&B CONVEX

S&B	einteilig	BH 10	-	50-SB-10-00-520	-	

LM SCHIENE

LM	einteilig	BH 17	40-LM-17-00-520	50-LM-17-00-520	53-LM-17-00-520	

PICATINNY / PICATINNY LONG

PT	einteilig	BH 20	-	50-PT-20-00-520	-	
		BH 20	-	50-PT-20-60-520	-	

*Abbildung ähnlich.

FÜR
CZ 550/557

FÜR CZ 550/557 (520)

	Bauhöhe	Zero	QD	FM	Ansicht QD
--	---------	------	----	----	------------

PULSAR APEX | Digsight | Trail - YUKON Sightline N455S | Sightline N475S

PA	einteilig	BH 10	40-PA-10-00-520	50-PA-10-00-520	-	
----	-----------	-------	-----------------	-----------------	---	---

PULSAR Trail2 / LRF | Digsight Ultra N355 | Digsight Ultra N450 / LRF | Digsight Ultra N455 / LRF

PA2	einteilig	BH 10	40-PA2-10-00-520	50-PA2-10-00-520	-	
-----	-----------	-------	------------------	------------------	---	---

**PULSAR Thermion I+II/Pro/LRF | Thermion Duo DXP50 | Duo DXP55 - INFIRAY Tube TL 35 | Tube TH 35 | Tube TH 50
LAHOUX Sight 35 - HIKMICRO Stellar SH 35 | SQ 35 | Stellar SH 50 | SQ 50 - NIGHT PEARL Marten TU 420 | Marten TU 430
Marten TU 450 | Marten TU 650 - GUIDE TU 420 | TU 430 | TU 450 | TU 620 | TU 630 | TU 650 - THERMTEC Ares 335 | 360 | 635 | 660**

TH	einteilig	BH 24	40-TH-24-00-520	50-TH-24-00-520	-	
----	-----------	-------	-----------------	-----------------	---	---

PULSAR Digex N450 | N455 | C50 - INFIRAY Tube TD 50L | Tube TH 50 V2 - HIKMICRO Alpex A50T | A50TN

DE	einteilig	BH 27	40-DE-27-00-520	50-DE-27-00-520	-	
----	-----------	-------	-----------------	-----------------	---	---

ATN Thor | Mars | X-Sight I + II

ATN	einteilig	BH 12	-	50-ATN-12-00-520*	-	
-----	-----------	-------	---	-------------------	---	---

*Ab Objektivdurchmesser 70 mm Art.Nr. 24-ATN-10 mitbestellen.
*From an objective diameter of 70 mm, item no. order the 24-ATN-10 at the same time.

ATN4/5 Thor 4 | Thor LT | X-Sight 4K Pro | X-Sight LTV | X-Sight 4K INT

ATN4/5	einteilig	BH 24	40-ATN4-24-00-520	50-ATN4-24-00-520	-	
--------	-----------	-------	-------------------	-------------------	---	---

YUKON PHOTON

YP	einteilig	BH 27	-	50-YP-27-00-520	-	
----	-----------	-------	---	-----------------	---	---

*Abbildung ähnlich.



FÜR **CZ 550/557** (520)

	Bauhöhe	Zero	QD	FM	Ansicht QD
--	---------	------	----	----	------------

PARD NV008P | NV008P LRF | SA 19 | 25 | 35 | 45 LRF - **SYTONG HT 60**

PD	einteilig	BH 13	-	50-PD-13-00-520	-	
----	-----------	-------	---	-----------------	---	--

PARD NV008S | NV008S LRF

PD2	einteilig	BH 13	40-PD2-13-00-520	50-PD2-13-00-520	-	
-----	-----------	-------	------------------	------------------	---	--

GUIDE TS 450

GT	einteilig	BH 17	-	50-GT-17-00-520	-	
----	-----------	-------	---	-----------------	---	--

INFIRAY Rico RH 35 | RH 50 | RL 42

IRR	einteilig	BH 10	40-IRR-10-00-520	50-IRR-10-00-520	-	
-----	-----------	-------	------------------	------------------	---	--

INFIRAY Saim SCP 19 | SCL 35 | SCT 35 | SCH 50 | SCT 35 V2 - **LIEMKE Sperber 19** | 25 | 35
NIGHT PEARL Fox 19 Hunt | Fox 35 Elite II | Fox 35 Hunt

IRS	einteilig	BH 16	40-IRS-16-00-520	50-IRS-16-00-520	-	
-----	-----------	-------	------------------	------------------	---	--

*Abbildung ähnlich.

HIKMICRO Thunder TH 25 | TH 35 | TE 19 PRO | TE 25 PRO | TQ 35 PRO | TQ 50 PRO - Panther PH 35L | PH 50L | PQ 35L | PQ 50L
Cheetah C32F-S | SL | SN | SNL

HMT	einteilig	BH 18	40-HMT-18-00-520	50-HMT-18-00-520	-	
-----	-----------	-------	------------------	------------------	---	--



FÜR **MERKEL**

FÜR MERKEL (900)

	Bauhöhe	Zero	QD	FM	Ansicht QD
--	---------	------	----	----	------------

RINGMONTAGE 1"/26 MM

Ø 1"/26	einteilig	BH 13 BH 16 BH 19	-	50-26-13-00-900 50-26-16-00-900 50-26-19-00-900	-	
---------	-----------	-------------------------	---	---	---	---

RINGMONTAGE 30 MM

Ø 30	einteilig	BH 13 BH 16 BH 19 BH 22	-	50-30-13-00-900 50-30-16-00-900 50-30-19-00-900 50-30-22-00-900	-	
------	-----------	----------------------------------	---	--	---	---

RINGMONTAGE 34 MM

Ø 34	einteilig	BH 13 BH 16 BH 19	-	50-34-13-00-900 50-34-16-00-900 50-34-19-00-900	-	
------	-----------	-------------------------	---	---	---	---

RINGMONTAGE 35 MM

Ø 35	einteilig	BH 13 BH 16 BH 19	-	50-35-13-00-900 50-35-16-00-900 50-35-19-00-900	-	
------	-----------	-------------------------	---	---	---	---

RINGMONTAGE 36 MM

Ø 36	einteilig	BH 13 BH 16 BH 19	-	50-36-13-00-900 50-36-16-00-900 50-36-19-00-900	-	
------	-----------	-------------------------	---	---	---	---

RINGMONTAGE 40 MM

Ø 40	einteilig	BH 13 BH 16 BH 19	-	50-40-13-00-900 50-40-16-00-900 50-40-19-00-900	-	
------	-----------	-------------------------	---	---	---	---

	Bauhöhe	Zero	QD	FM	Ansicht QD
--	---------	------	----	----	------------

SWAROVSKI SR

SR	einteilig	BH 10	-	50-SR-10-00-900	-	
----	-----------	-------	---	-----------------	---	---



ZEISS ZM/VM

VM	einteilig	BH 7	-	50-VM-07-00-900	-	
----	-----------	------	---	-----------------	---	---

LM SCHIENE

LM	einteilig	BH 14	-	50-LM-14-00-900	-	
----	-----------	-------	---	-----------------	---	---

PICATINNY / PICATINNY LONG

PT	einteilig	BH 20	-	50-PT-20-00-900	-	
	einteilig	BH 20	-	50-PT-20-110-900	-	

FÜR MERKEL (900)

	Bauhöhe	Zero	QD	FM	Ansicht QD
--	---------	------	----	----	------------

DOCTER | NOBLEX | GECO | LEICA TEMPUS | VORTEX | BURRIS FAST FIRE | KAHLES HELIA RD

DS	einteilig slight long	BH 6	-	52-DS-06-00-900	-	
----	--------------------------	------	---	-----------------	---	---

AIMPOINT MICRO | HOLOSUN | GPO SPECTRA DOT

AM	einteilig slight long	BH 6	-	52-AM-06-00-900	-	
----	--------------------------	------	---	-----------------	---	---

PICATINNY

PT	einteilig slight long	BH 12	-	52-PT-12-00-900	-	
----	--------------------------	-------	---	-----------------	---	---

FÜR MERKEL (900)

	Bauhöhe	Zero	QD	FM	Ansicht QD
--	---------	------	----	----	------------

PULSAR APEX | Digisight | Trail - YUKON Sightline N455S | Sightline N475S

PA	einteilig	BH 10	-	50-PA-10-00-900	-	
----	-----------	-------	---	-----------------	---	---

PULSAR Trail2 / LRF | Digisight Ultra N355 | Digisight Ultra N450 / LRF | Digisight Ultra N455 / LRF

PA2	einteilig	BH 10	-	50-PA2-10-00-900	-	
-----	-----------	-------	---	------------------	---	---

PULSAR Thermion I+II/Pro/LRF | Thermion Duo DXP50 | Duo DXP55 - INFIRAY Tube TL 35 | Tube TH 35 | Tube TH 50
LAHOUX Sight 35 - HIKMICRO Stellar SH 35 | SQ 35 | Stellar SH 50 | SQ 50 - NIGHT PEARL Marten TU 420 | Marten TU 430
Marten TU 450 | Marten TU 650 - GUIDE TU 420 | TU 430 | TU 450 | TU 620 | TU 630 | TU 650 - THERMTEC Ares 335 | 360 | 635 | 660

TH	einteilig	BH 24	-	50-TH-24-00-900	-	
----	-----------	-------	---	-----------------	---	---

PULSAR Digex N450 | N455 | C50 - INFIRAY Tube TD 50L | Tube TH 50 V2 - HIKMICRO Alpex A50T | A50TN

DE	einteilig	BH 27	-	50-DE-27-00-900	-	
----	-----------	-------	---	-----------------	---	---

ATN Thor | Mars | X-Sight I + II

ATN	einteilig	BH 12	-	50-ATN-12-00-900*	-	
-----	-----------	-------	---	-------------------	---	---

*Ab Objektivdurchmesser 70 mm Art.Nr. 24-ATN-10 mitbestellen.
*From an objective diameter of 70 mm, item no. order the 24-ATN-10 at the same time.

ATN4/5 Thor 4 | Thor LT | X-Sight 4K Pro | X-Sight LTV | X-Sight 4K INT

ATN4/5	einteilig	BH 24	-	50-ATN4-24-00-900	-	
--------	-----------	-------	---	-------------------	---	---

YUKON PHOTON

YP	einteilig	BH 27	-	50-YP-27-00-900	-	
----	-----------	-------	---	-----------------	---	---

*Abbildung ähnlich.

DEDAL HUNTER

DH	einteilig	BH 14	-	50-DH-14-00-900	-	
----	-----------	-------	---	-----------------	---	---



FÜR MERKEL (900)

	Bauhöhe	Zero	QD	FM	Ansicht QD
--	---------	------	----	----	------------

TVT ARCHER TSA

AR	einteilig	BH 13	-	50-AR-13-00-900	-	
----	-----------	-------	---	-----------------	---	---

PARD NV008P | NV008P LRF | SA 19 | 25 | 35 | 45 LRF - SYTONG HT 60

PD	einteilig	BH 13	-	50-PD-13-00-900	-	
----	-----------	-------	---	-----------------	---	---

PARD NV008S | NV008S LRF

PD2	einteilig	BH 13	-	50-PD2-13-00-900	-	
-----	-----------	-------	---	------------------	---	---

GUIDE TS 450

GT	einteilig	BH 17	-	50-GT-17-00-900	-	
----	-----------	-------	---	-----------------	---	---

INFIRAY Rico RH 35 | RH 50 | RL 42

IRR	einteilig	BH 10	-	50-IRR-10-00-900	-	
-----	-----------	-------	---	------------------	---	---

INFIRAY Saim SCP 19 | SCL 35 | SCT 35 | SCH 50 | SCT 35 V2 - LIEMKE Sperber 19 | 25 | 35 NIGHT PEARL Fox 19 Hunt | Fox 35 Elite II | Fox 35 Hunt

IRS	einteilig	BH 16	-	50-IRS-16-00-900	-	
-----	-----------	-------	---	------------------	---	---

*Abbildung ähnlich.

HIKMICRO Thunder TH 25 | TH 35 | TE 19 PRO | TE 25 PRO | TQ 35 PRO | TQ 50 PRO - Panther PH 35L | PH 50L | PQ 35L | PQ 50L Cheetah C32F-S | SL | SN | SNL

HMT	einteilig	BH 18	-	50-HMT-18-00-900	-	
-----	-----------	-------	---	------------------	---	---



FÜR **12MM PRISMA**

FÜR 12MM PRISMA (950)

	Bauhöhe	Zero	QD	FM	Ansicht QD
--	---------	------	----	----	------------

RINGMONTAGE 1"/26 MM

Ø 1"/26	einteilig	BH 16 BH 19 BH 22	-	50-26-16-00-950 50-26-19-00-950 50-26-22-00-950	-	
---------	-----------	-------------------------	---	---	---	---

RINGMONTAGE 30 MM

Ø 30	einteilig	BH 16 BH 19 BH 22 BH 25	-	50-30-16-00-950 50-30-19-00-950 50-30-22-00-950 50-30-25-00-950	-	
------	-----------	----------------------------------	---	--	---	---

RINGMONTAGE 34 MM

Ø 34	einteilig	BH 16 BH 19 BH 22	-	50-34-16-00-950 50-34-19-00-950 50-34-22-00-950	-	
------	-----------	-------------------------	---	---	---	---

RINGMONTAGE 35 MM

Ø 35	einteilig	BH 16 BH 19 BH 22	-	50-35-16-00-950 50-35-19-00-950 50-35-22-00-950	-	
------	-----------	-------------------------	---	---	---	---

RINGMONTAGE 36 MM

Ø 36	einteilig	BH 16 BH 19 BH 22	-	50-36-16-00-950 50-36-19-00-950 50-36-22-00-950	-	
------	-----------	-------------------------	---	---	---	---

RINGMONTAGE 40 MM

Ø 40	einteilig	BH 16 BH 19 BH 22	-	50-40-16-00-950 50-40-19-00-950 50-40-22-00-950	-	
------	-----------	-------------------------	---	---	---	---

	Bauhöhe	Zero	QD	FM	Ansicht QD
--	---------	------	----	----	------------

SWAROVSKI SR

SR	einteilig	BH 10	-	50-SR-10-00-950	-	
----	-----------	-------	---	-----------------	---	---

ZEISS ZM/VM

VM	einteilig	BH 9	-	50-VM-09-00-950	-	
----	-----------	------	---	-----------------	---	---

S&B CONVEX

S&B	einteilig	BH 10	-	50-SB-10-00-950	-	
-----	-----------	-------	---	-----------------	---	---

LM SCHIENE

LM	einteilig	BH 17	-	50-LM-17-00-950	-	
----	-----------	-------	---	-----------------	---	---

PICATINNY / PICATINNY LONG

PT	einteilig	BH 20	-	50-PT-20-00-950	-	
----	-----------	-------	---	-----------------	---	---

*Abbildung ähnlich.

MULTIRAIL/PICATINNYRAIL

MULTIRAIL/PICATINNYRAIL

Picatinny - Blaser

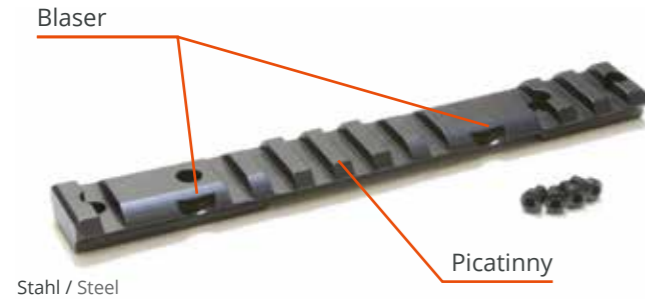

Picatinny



Waffe	Bestellnummer Multirail Picatinny - Blaser
Anschütz 1771	12-PT-800-00-053
Anschütz 1780	12-PT-800-00-151
Benelli Argo	12-PT-800-00-273
Benelli Lupo	12-PT-800-00-054
Bergara BA 13	12-PT-800-00-034
Bergara B 14 LA*	12-PT-800-00-041
Bergara B 14 SA*	12-PT-800-00-042
Bergara B 14 Premier Series LA*	12-PT-800-00-064
Bergara B 14 Premier Series SA*	12-PT-800-00-063
FN Browning BAR/Maral	12-PT-800-00-003
FN Browning A - Bolt 3 LA*	12-PT-800-00-037
FN Browning A - Bolt 3 SA*	12-PT-800-00-038
Franchi Horizon	12-PT-800-00-050
Haenel Jäger 10 ab Nr. 921	12-PT-800-00-226
Heym SR30	12-PT-800-00-206
Heym SR21	12-PT-800-00-306
Howa 1500 LA*	12-PT-800-00-218
Howa 1500 SA*	12-PT-800-00-217
Howa 1500 MA*	12-PT-800-00-219
Krico 600	12-PT-800-00-033
Marlin 1895/444/338/336/308	12-PT-800-00-036
Mauser M12 (alt bis SN 29.999)	12-PT-800-00-020
Mauser M12 (neu ab SN 30.000)	12-PT-800-00-043
Mauser M18	12-PT-800-00-007
Mauser K98 (ohne Wulst)	12-PT-800-00-026
Remington 700 LA*	12-PT-800-00-009
Remington 700 SA*	12-PT-800-00-008
Remington 7400/7600/750	12-PT-800-00-013
Rohling	12-PT-800-00-000
Sako 85	12-PT-800-00-052
Sauer 100/101	12-PT-800-00-014
Sauer 202	12-PT-800-00-407
Sauer 202 Magnum	12-PT-800-00-408
Sauer 404	12-PT-800-00-650
Steyr Mod. - SBS/SM12/Classic Größe L	12-PT-800-00-018
Steyr Mod. - SBS/SM12/Classic Größe M	12-PT-800-00-022
Steyr Mod. - SBS/SM12/Classic Größe S	12-PT-800-00-025
Steyr Mod. - SBS/SM12/Classic Größe SL	12-PT-800-00-039

Bestellnummer Picatinny	Bestellnummer Picatinny - 20MOA
-	-
11-PT-ST-00-151	-
11-PT-ST-00-273	-
11-PT-ST-00-054	-
11-PT-ST-00-034	-
11-PT-ST-00-041	11-PT-ST-00-041-20MOA
11-PT-ST-00-042	11-PT-ST-00-042-20MOA
11-PT-ST-00-064	11-PT-ST-00-064-20MOA
11-PT-ST-00-063	11-PT-ST-00-063-20MOA
11-PT-ST-00-003	-
11-PT-ST-00-037	-
11-PT-ST-00-038	-
11-PT-ST-00-050	-
11-PT-ST-00-226	-
11-PT-ST-00-206	-
11-PT-ST-00-306	-
11-PT-ST-00-218	11-PT-ST-00-218-20MOA
11-PT-ST-00-217	11-PT-ST-00-217-20MOA
11-PT-ST-00-219	-
11-PT-ST-00-033	-
11-PT-ST-00-036	-
11-PT-ST-00-020	-
11-PT-ST-00-043	-
11-PT-ST-00-007	11-PT-ST-00-007-20MOA
11-PT-ST-00-026	11-PT-ST-00-026-20MOA
11-PT-ST-00-009	11-PT-ST-00-009-20MOA
11-PT-ST-00-008	11-PT-ST-00-008-20MOA
11-PT-ST-00-013	-
11-PT-ST-00-000	-
11-PT-ST-00-052	-
11-PT-ST-00-014	11-PT-ST-00-014-20MOA
11-PT-ST-00-407	11-PT-ST-00-407-20MOA
11-PT-ST-00-408	11-PT-ST-00-408-20MOA
-	-
11-PT-ST-00-018	-
11-PT-ST-00-022	-
11-PT-ST-00-025	-
11-PT-ST-00-039	-

* LA = long action; SA = short action; MA = mini action

Waffe	Bestellnummer Multirail Picatinny - Blaser
Tikka T3/T3x	12-PT-800-00-400
Tikka M55	12-PT-800-00-401
Tikka Mod. T1x	12-PT-800-00-404
Zoli 1900	12-PT-800-00-305

Bestellnummer Picatinny	Bestellnummer Picatinny - 20MOA
11-PT-ST-00-400	11-PT-ST-00-400-20MOA
11-PT-ST-00-401	-
11-PT-ST-00-404	-
11-PT-ST-00-305	-

weitere Modelle folgen

Waffensystem	Bestellnummer
Weaver/Picatinny z.B. Merkel Helix	13-800-ST-00-200



Super flach mit nur 5mm Bauhöhe. Speziell für Blasermontagen.

BASEN - WEAVER - ZWEITEILIG

BASEN - WEAVER - TWO PIECE



Bestellnr.: 10-00-WKZ
Order number: 10-00-WKZ

Fabrikat	Modell	WKZ	Fabrikat	Modell	WKZ	Fabrikat	Modell	WKZ
Anschütz	1780	151	Heckler & Koch	SLB 2000-Light	187	Rössler	Titan 3 / Titan 6	459
Anschütz	1574	154	Heym	SR 20	060	Santa Barbara	Mauser	044
Benelli	ARGO	273	Heym	SR 21	306	Sauer	200	059
Bergara	BA14	040	Heym	SR 30	206	Sauer	202	406
Carl Gustav	1900	005	Howa	1500	216	Sauer	80, 90, 92	015
Carl Gustav	2000	194	Krico	600 / 700 / 900 / 902	006	Sauer	100 / 101	014
Carl Gustav	3000	215	Mauser	225 Titan	145	Steyr	Mod. L	093
Carl Gustav	4000	259	Mauser	K 98 / M12 (alt bis SN 29.999)	010	Steyr	Mod. M Luxus L M S	086
Fabarm	Iris	403	Mauser	M12 (neu ab SN 30.000)	043	Steyr	Mod. SL	017
FN Browning	European	143	Mauser	M18	007	Steyr	SBS96 / SM12 / Classic	027
FN Browning	Brow Mauser	004	Merkel	SR 1	186	Swiss Arms	SHR 970	175
FN Browning	BAR / Maral	003	Merkel	SR 1 Basic	286	Voere	Kufstein 2165	021
FN Browning	BLR	103	Remington	700	012	Voere Neu! Alu	Titan II	045
Haenel	Jäger 10, ab Nr. 921	226	Remington	750 / 740 / 742 / 760	074	Zastava	Mod. 70	049
						Zoli	1900 Repetierer	305

DOUBLE SIGHT

DOUBLE SIGHT

Bestellnr.: 10-00-WKZ
 Order number: 10-00-WKZ



Ringoberteil mit Universalschnittstelle für alle INNOMOUNT Ringmontagen mit Aluringen

Ring upper part with universal interface for all INNOMOUNT ringmounts with alu rings

Ringdurchmesser	Ausrichtung 90°	Ausrichtung 45°
1"/26 mm	22-26-90	22-26-45
30 mm	22-30-90	22-30-45
34 mm	22-34-90	22-34-45
35 mm	22-35-90	22-35-45
36 mm	22-36-90	22-36-45
40 mm	22-40-90	22-40-45



2/3 Ring mit Universalschnittstelle für alle Schienen und Ringversionen

2/3 ring with universal interface for all rail and ring versions

Ringdurchmesser	Ausrichtung 90°	Ausrichtung 45°
1"/26 mm	23-26-90	23-26-45
30 mm	23-30-90	23-30-45
34 mm	23-34-90	23-34-45
36 mm	23-36-90	23-36-45
40 mm	23-40-90	-



Ringoberteil mit Universalschnittstelle für alle INNOMOUNT Ringmontagen

Ring upper part with universal interface for all INNOMOUNT ringmounts



Ringdurchmesser	Ausrichtung 90°	Ausrichtung 45°
1"/26 mm	21-26-90	21-26-45
30 mm	21-30-90	21-30-45
34 mm	21-34-90	21-34-45
35 mm	21-35-90	21-35-45
36 mm	21-36-90	21-36-45
40 mm	21-40-90	21-40-45

Artikelnr. für Aufpreis Article number for additional charge

Bestellbeispiel
 Ordering example
 1x | Montage/Mount | 50-30-14-00-200
 1x | Ringoberteil/Ring upper part | 21-30-90



Adapter mit Universalschnittstelle

Adapter with universal interface

		Aufsatz
Docter Sight	BH5	24-DS-05
Aimpoint Micro	BH5	24-AM-05
Picatinny	BH10	24-PT-10
Picatinny	BH15	24-PT-15

Aimpoint Acro BH7 24-AC-07*

* Passend nur in Verbindung mit 24-AM-05
 * Only suitable in combination with 24-AM-05

ARTIKELNUMMER

ITEM NUMBER

BRÜCKENSCHWENKMONTAGEN

SWING MOUNTS

Montagetyp / Mounting type

Oberteil / Upper part

Bauhöhe Grundkörper / Construction height base
Angaben in mm / dimensions in mm

Bauhöhe/Kröpfung - Vorderfuss
Construction height/offset - front foot
Angaben in mm / dimensions in mm

Bauhöhe Distanzrolle
Construction height - Distance rings
Angaben in mm / dimensions in mm

Verschlusskörper / Locking system

Waffenkennzahl* / ID No.*

70-SR-11-002-010-150-WKZ

- 26 – Ringe 25,4/26 mm
- 30 – Ringe 30 mm
- 34 – Ringe 34 mm
- 35 – Ringe 35 mm
- 36 – Ringe 36 mm
- 40 – Ringe 40 mm
- VM – Zeisschiene
- LM – 70° Prismenschiene
- SR – Swarovskischiene

- PT – Picatinny
- PA – Pulsar
- YP – Yukon Photon
- ATN – X-Sight I+II
- ATN4 – X-Sight 4K
- ...

- 002 – gerade; BH 2 mm
- 004 – gerade; BH 4 mm
- 006 – gerade; BH 6 mm
- 010 – gerade; BH 10 mm
- 206 – gekröpft 20 mm; BH 6 mm
- 406 – gekröpft 40 mm; BH 6 mm

- WKZ – siehe Seite 3
- 000 – siehe Seite 27
- 150 – Hebelverschluss (15 mm Prisma)
- 160 – Drehbolzenverschluss (EAW)
- 010 – Bauhöhe 1 mm
- 015 – Bauhöhe 1,5 mm
- 020 – Bauhöhe 2 mm
- ...
- 125 – Bauhöhe 12,5 mm
- 130 – Bauhöhe 13 mm
- 150 – Bauhöhe 15 mm

70 – Brückenschwenkmontage



Hebelverschluss (15 mm Prisma)		
SR	Swarovski SR	70-SR-12-XXX-YYY-150-WKZ
VM	Zeiss ZM/VM	70-VM-12-XXX-YYY-150-WKZ
PA	Pulsar APEX / Digisight / Trail	70-PA-14-XXX-YYY-150-WKZ
PA2	Pulsar Trail2 / Digisight Ultra N450 & N455	70-PA2-14-XXX-YYY-150-WKZ
TH	Pulsar Thermion	70-TH-23-XXX-YYY-150-WKZ
DE	Pulsar Digex	70-DE-26-XXX-YYY-150-WKZ
YP	Yukon	70-YP-30-XXX-YYY-150-WKZ
DH	Dedal - Hunter	70-DH-16-XXX-YYY-150-WKZ
ATN	ATN	70-ATN-15-XXX-YYY-150-WKZ
ATN4	ATN 4	70-ATN4-23-XXX-YYY-150-WKZ
IRS	InfiRay Saim	70-IRS-15-XXX-YYY-150-WKZ
IRX	InfiRay Xsight	70-IRX-15-XXX-YYY-150-WKZ
IRR	InfiRay Rico	70-IRR-14-XXX-YYY-150-WKZ
PD	Pard 008 / SA Series	70-PD-15-XXX-YYY-150-WKZ
AR	TVT - Archer	70-AR-14-XXX-YYY-150-WKZ
GT	Guide TS450	70-GT-28-XXX-YYY-150-WKZ
PT	Picatinny	70-PT-18-XXX-YYY-150-WKZ
Ø 40	Ring 40 mm*	70-40-17-XXX-YYY-150-WKZ
Ø 36	Ring 36 mm*	70-36-17-XXX-YYY-150-WKZ
Ø 35	Ring 35 mm*	70-35-17-XXX-YYY-150-WKZ
Ø 34	Ring 34 mm*	70-34-17-XXX-YYY-150-WKZ
Ø 30	Ring 30 mm*	70-30-17-XXX-YYY-150-WKZ
Ø 26	Ring 26 mm*	70-26-17-XXX-YYY-150-WKZ

Drehbolzenverschluss EAW		
SR	Swarovski SR	70-SR-12-XXX-YYY-160-WKZ
VM	Zeiss ZM/VM	70-VM-12-XXX-YYY-160-WKZ
PA	Pulsar APEX / Digisight / Trail	70-PA-14-XXX-YYY-160-WKZ
PA2	Pulsar Trail2 / Digisight Ultra N450 & N455	70-PA2-14-XXX-YYY-160-WKZ
TH	Pulsar Thermion	70-TH-23-XXX-YYY-160-WKZ
DE	Pulsar Digex	70-DE-26-XXX-YYY-160-WKZ
YP	Yukon	70-YP-30-XXX-YYY-160-WKZ
DH	Dedal - Hunter	70-DH-16-XXX-YYY-160-WKZ
ATN	ATN	70-ATN-15-XXX-YYY-160-WKZ
ATN4	ATN 4	70-ATN4-23-XXX-YYY-160-WKZ
IRS	InfiRay Saim	70-IRS-15-XXX-YYY-160-WKZ
IRX	InfiRay Xsight	70-IRX-15-XXX-YYY-160-WKZ
IRR	InfiRay Rico	70-IRR-14-XXX-YYY-160-WKZ
PD	Pard 008 / SA Series	70-PD-15-XXX-YYY-160-WKZ
AR	TVT - Archer	70-AR-14-XXX-YYY-160-WKZ
GT	Guide TS450	70-GT-28-XXX-YYY-160-WKZ
PT	Picatinny	70-PT-18-XXX-YYY-160-WKZ
Ø 40	Ring 40 mm*	70-40-17-XXX-YYY-160-WKZ
Ø 36	Ring 36 mm*	70-36-17-XXX-YYY-160-WKZ
Ø 35	Ring 35 mm*	70-35-17-XXX-YYY-160-WKZ
Ø 34	Ring 34 mm*	70-34-17-XXX-YYY-160-WKZ
Ø 30	Ring 30 mm*	70-30-17-XXX-YYY-160-WKZ
Ø 26	Ring 26 mm*	70-26-17-XXX-YYY-160-WKZ

* Ringmontagen sind in der Bauhöhe gemäß Tabelle sowie in +3 und +6 mm höheren Ausführungen erhältlich. Bitte bei der Bestellangabe berücksichtigen.
* Ring mountings are available in the construction heights as listed in the table as well as in +3 and +6 mm higher versions. Please take this into account for ordering.

XXX = Bauhöhe Vorderfuss | YYY = Bauhöhe Distanzrolle | WKZ (siehe Seite 3) / ohne WKZ = 000
XXX = Construction height front foot | YYY = Construction height distance rings | WKZ (see page 3) / without WKZ = 000 (see page 27)

BRÜCKENSCHWENKMONTAGEN

SWING MOUNTS



Vorderfuß Bestellnr.: 24-VF-...
Front Foot order number: 24-VF-...

Bauhöhe BV	Kröpfung	XXX
2 mm	gerade	002
4 mm	gerade	004
6 mm	gerade	006
10 mm	gerade	010
6 mm*	gekröpft; 20 mm	206
6 mm*	gekröpft; 40 mm	406

Distanzrolle Bestellnr.: 24-DR-...
Distance Rings order number: 24-DR-...

Bauhöhe BD	YY	YYY
1 mm	0,8 - 1,2	010
1,5 mm	1,3 - 1,7	015
2 mm	1,8 - 2,2	020
2,5 mm	2,3 - 2,7	025
3 mm	2,8 - 3,2	030
3,5 mm	3,3 - 3,7	035
... Höhe durchgehend bis 13 mm		
13 mm	12,8 - 13,2	130
15 mm		150

* bei Abstand der mittleren Basenbohrungen (B) größer 104 mm
* for distance of middle whols of bases (B) larger than 104 mm



BESTELLBEISPIEL

ORDER EXAMPLE

70-SR-12-**XXX-YYY**-150-000 (für WKZ = 000)

1. Messen des Bauhöhen-Unterschieds (BU)

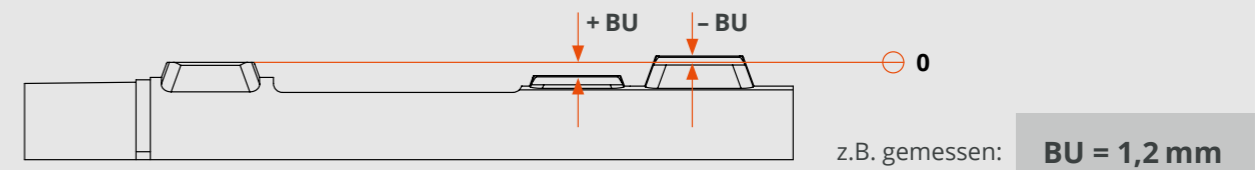

2. Bauhöhe Vorderfuß (BV)

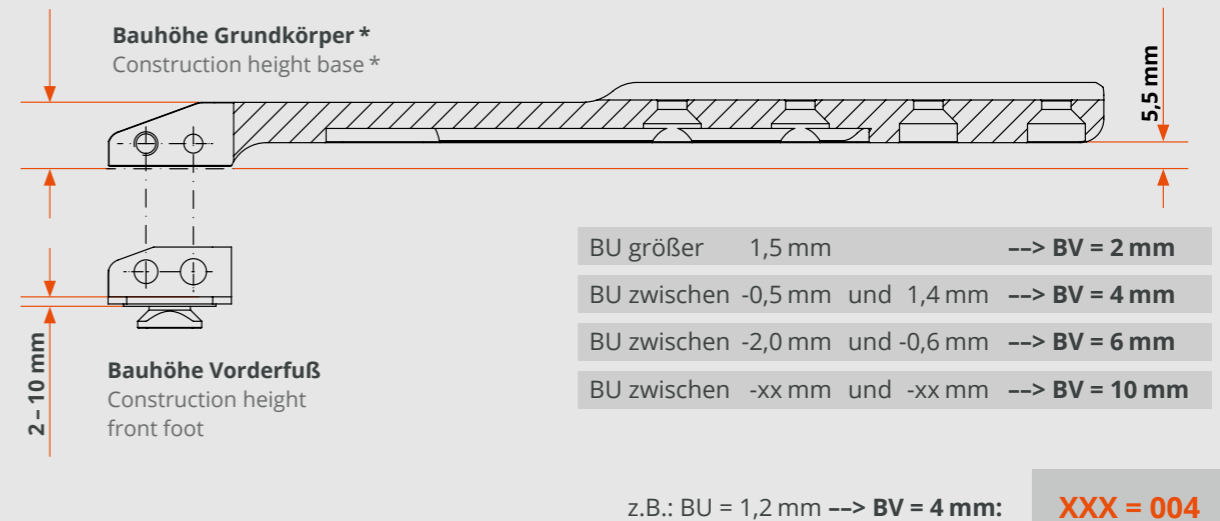

3. Bauhöhe Distanzrolle (BD)

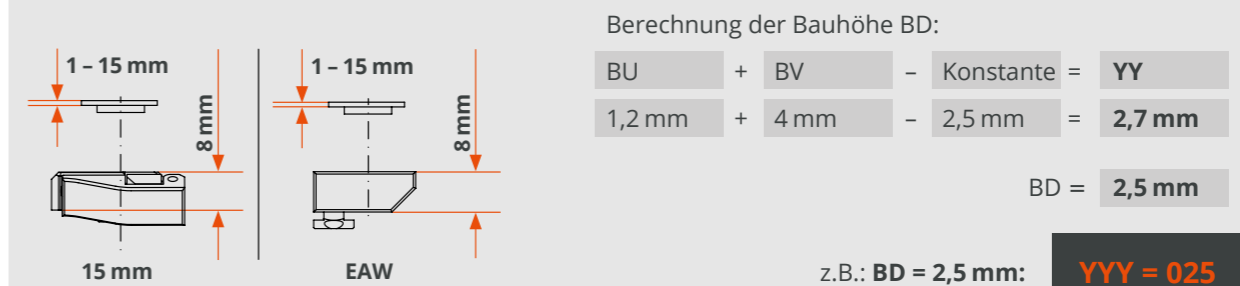

70-SR-12-**004-025**-150-000

TAKTISCHE MONTAGE

TACTICAL MOUNT



Abbildung zeigt Schnellspannmontage mit und ohne Universalschnittstelle
Picture shows quick release mounting with and without universal interface

Ø	Bauhöhe	Vorneigung	Schnellspannmontage	Festmontage
30	18		60-30-18-00-200	63-30-18-00-200
30	23		60-30-23-00-200	63-30-23-00-200
30	18	20 MOA	60-30-18-00-200-20MOA	63-30-18-00-200-20MOA
30	23	20 MOA	60-30-23-00-200-20MOA	63-30-23-00-200-20MOA
34	16		60-34-16-00-200	63-34-16-00-200
34	21		60-34-21-00-200	63-34-21-00-200
34	16	20 MOA	60-34-16-00-200-20MOA	-
34	21	20 MOA	60-34-21-00-200-20MOA	63-34-21-00-200-20MOA

Montagetyp / Mounting type

Oberteil / Upper part

Bauhöhe / Construction height
Angaben in mm / dimensions in mm

Kröpfung / Offset
Angaben in mm / dimensions in mm

Waffenkennzahl / Weapon code

Vorneigung / Pre-tilt
Angaben in MOA / data in MOA

60-30-18-00-200-20MOA

200 – Picatinny

- 60 – QD einteilig
- 63 – FM einteilig
- 64 – QD einteilig Flex
- 65 – FM einteilig Flex

- 30 – Ringe 30 mm
- 34 – Ringe 34 mm
- VM – Zeiss-Schiene
- SR – Swarovski-Schiene

Ringoberteil mit Universalschnittstelle für alle Taktische Montagen

Ring upper part with universal interface for all Tactical mounts



Ringdurchmesser		
30 mm	vorne	26-30-00
	hinten	26-30-01-20MOA
	hinten	26-30-02-20MOA
34 mm	vorne	26-34-00
	hinten	26-34-01-20MOA
	hinten	26-34-02-20MOA

Artikelnr. für Aufpreis
Article number for additional charge

Bestellbeispiel

Ordering example

1x | Montage/Mount | 60-30-18-00-200
1x/2x | Ringoberteil/Ring upper part | 26-30-00

Ringoberteil mit Universalschnittstelle für alle Taktische Montagen

Ring upper part with universal interface for all Tactical mounts

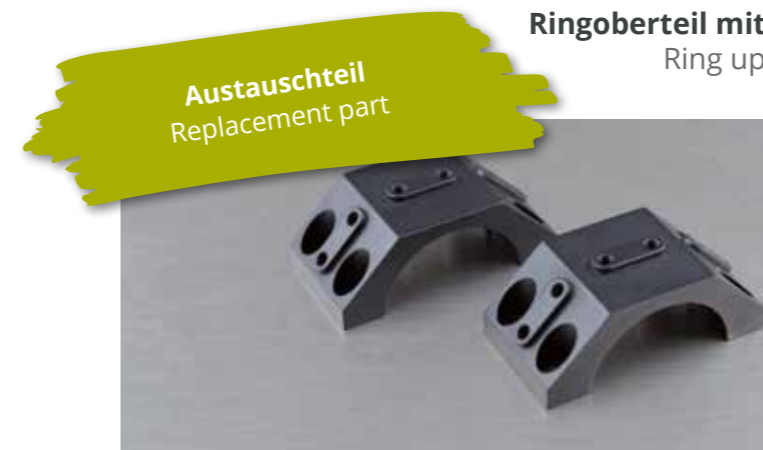

Ringdurchmesser		
30 mm	vorne	27-30-00
	hinten	27-30-01-20MOA
	hinten	27-30-02-20MOA
34 mm	vorne	27-34-00
	hinten	27-34-01-20MOA
	hinten	27-34-02-20MOA

TAKTISCHE MONTAGE - FLEX

TACTICAL MOUNT - FLEX



0 MOA → ∞

PATENTED

1. Ringe tauschen Change rings



0-MOA



2. Ringe drehen Turn rings



20-MOA



Vorneigung veränderbar:
0 - 20MOA / 20 - 40MOA
changable pre-tilt:
0 - 20MOA / 20 - 40MOA

Ringe auswechselbar
changeable rings

Durchmesser	Bauhöhe	Vorneigung	Bestellnummer Schnellspannmontage (QD)	Bestellnummer Festmontage (FM)
30	23	0 - 20MOA	64-30-23-00-200-20MOA	65-30-23-00-200-20MOA
30	23	20 - 40MOA	64-30-23-00-200-40MOA	65-30-23-00-200-40MOA
34	21	0 - 20MOA	64-34-21-00-200-20MOA	65-34-21-00-200-20MOA
34	21	20 - 40MOA	64-34-21-00-200-40MOA	65-34-21-00-200-40MOA



Durchmesser	Bauhöhe	Vorneigung	Bestellnummer Ringpaar
30	12	0 - 20MOA	28-30-12-20MOA
30	12	20 - 40MOA	28-30-12-40MOA
34	10	0 - 20MOA	28-34-10-20MOA
34	10	20 - 40MOA	28-34-10-40MOA

Abbildung zeigt 2 Ringpaare mit Universalschnittstelle.
Picture shows 2 ring pairs with universal interface.

TAKTISCHE MONTAGE - FLEX

TACTICAL MOUNT - FLEX



50 mm Offset



PATENTED

Abbildung zeigt Montage mit Universalschnittstelle.
Picture shows mounting with universal interface.

Durchmesser / Schiene	Bauhöhe	Vorneigung	Bestellnummer Schnellspannmontage (QD)	Bestellnummer Festmontage (FM)
30	34	0 - 20MOA	64-30-34-50-200-20MOA	65-30-34-50-200-20MOA
34	32	0 - 20MOA	64-34-32-50-200-20MOA	65-34-32-50-200-20MOA
Swarovski	24	ohne	64-SR-24-50-200	65-SR-24-50-200
Zeiss	23	ohne	64-VM-23-50-200	65-VM-23-50-200
Swarovski	24	20MOA	64-SR-24-50-200-20MOA	65-SR-24-50-200-20MOA
Zeiss	23	20MOA	64-VM-23-50-200-20MOA	65-VM-23-50-200-20MOA



- **Kröpfung + 50mm durch Adapterplatte**
Offset +50mm with Offsetadapter
- **0 - 20MOA Vorneigung bei Ringmontage**
0 - 20MOA pre-tilt with rings



Adapterplatte	Bauhöhe	Bestellnummer
Ring	11 mm	28-00-11-50
Zeiss	12 mm	28-VM-12-50
Swarovski	13 mm	28-SR-13-50
Zeiss	12 mm	28-VM-12-50-20MOA
Swarovski	13 mm	28-SR-13-50-20MOA

Adapterplatte wird ohne Ringe geliefert.
Offsetadapter delivery without rings.

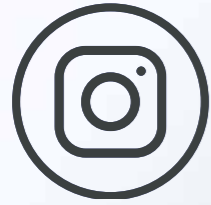

innogun_official



Innogun_official



09732 7864660



**"DIE
ZUFRIEDENHEIT
DER KUNDEN STEHT
BEI UNS AN ERSTER
STELLE."**

Julian Schäfer
Sales Manager



INN@MOUNT

by INNOGUN

